

# ACCESS & SECURITY SOLUTIONS

Multi-door Interlocks - Annunciators - Switch Controls - Mag Locks and Strikes

## What you want When you want it



**DORTRONICS  
SYSTEMS, INC.**



Proudly made  
in the U.S.A.



Dortronics Systems, Inc., is a U.S. manufacturer of electric locking hardware, it is the security industry's "quick-ship" supplier of standard and customized access control devices.

Standard products include: electromagnetic locks; electric strikes; multi door interlocks & mantrap controllers; power supplies; key switch controls; pushbutton switches; digital keypads; delayed egress systems; alarm annunciators; security consoles; high security locks; PIR motion sensing door releases; and emergency pull stations.

Electromagnetic locks, egress bars and switch controls are stocked in most architectural finishes to compliment other building hardware finishes.

With in-house engineering and manufacturing, Dortronics can customize existing products or create a totally new solution for your access control problem.

Competitively priced, most orders ship within a day. With representation throughout the United States and Internationally Dortronics provides unmatched quality service and technical support.

***Off the shelf or off the drawing board - Dortronics delivers.***

## 300 SERIES MINI MAGNETIC LOCK

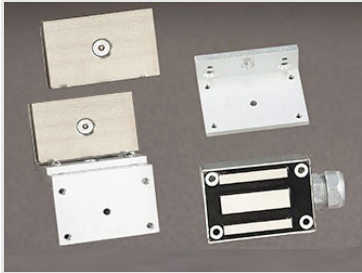

300 Pounds Holding Force

Ultra Small Size  
2"H x 3"W x 1-1/16"D

Field Selectable 12 or 24  
DC Operating Voltage

Low Current Draw

The MM-300 electromagnetic lock is ideal for securing cabinets, drawers and small gates. Providing 300 pounds of holding force, these locks can be easily mounted for any application using brackets and clamps. The small profile allows installation of these devices to secure cabinet doors and drawers. The electromagnet is in a stainless steel housing, which can be easily mounted to just about any surface.

## 1000 SERIES INDUSTRIAL MAGNETIC LOCK



1200 Pounds Holding Force

Compact Size

Field Selectable Voltage

Extra Low Current Draw

The 1000 Series electromagnetic locks can be used in harsh environments to secure doors and gates. All electronics are sealed in epoxy and are protected by the Stainless Steel housing. The armature and exposed face of the electromagnet are Electro-plated to resist rust and corrosion. A rigid conduit fitting can be provided on one end of the lock to protect power wiring in gate control installations.

## 1100 SERIES ARCHITECTURAL MAGNETIC LOCK



650 / 1200 / 1500 Pounds  
Holding Force

Shallow 2" Mounting Profile

Field Selectable 12/24 DC  
Voltage

Low Current Draw

These electro-magnetic locks provide positive, instantaneous door control. Available for inswing, outswing and sliding single or paired doors. Filler plates, angle brackets, and custom mounting hardware are available in architectural finishes to compliment any decor. Maglocks are inherently failsafe, releasing instantly upon command or loss of power and have no parts to wear.

## 1100 SERIES MORTISE MAGLOCK & DOOR PULL



ML-1100 @ 1,000 lbs.  
Holding Force

Matching Door Pull  
Hardware

Architectural Finishes are  
Available

Optional Custom Engraving

1100 Series Mortise Lock and Pull System is available as the ML-1100 (1,000 lbs. force) and the DPA1100 thru bolted door pull handle. Attractive architectural appearance, while providing full security. Using the DPA series pull with the mortised maglock allows the force of the magnet to be directly opposite the direction of pull; preventing a mechanical advantage when force is applied to the pull handle.

## 3300 SERIES ELECTRIC STRIKES



Field Selectable Fail-Safe or Fail-Secure

Universal Operating Voltage 12 to 24 VDC

Continuous Duty Operation

Heavy Duty Stainless Steel Latch Jaw

3300 Series electric strikes are supplied with both an ANSI strike plate for metal frames and an 8 inch tall strike plate for wood or special installations. Simple field adjustment will convert these strikes from fail-secure to fail-safe operation. The power converter, supplied, allows operation from any 12 to 24 volt DC power source. Optional latch sensor provides a form C output to indicate secure or unsecure door status.

## 4200 SERIES POWER SUPPLIES & ACCESSORIES

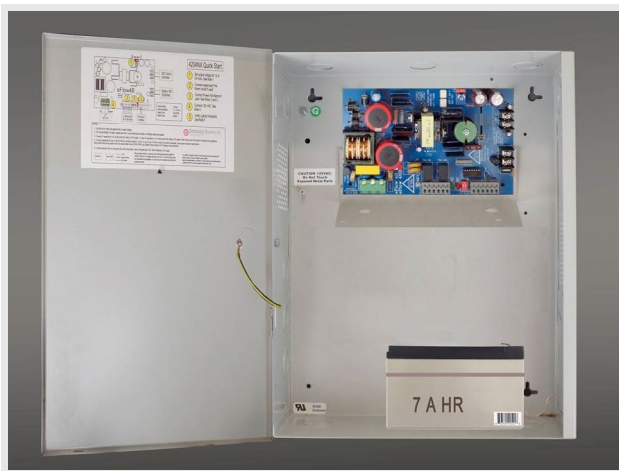

UL 294 Listed Class 2 Limited Output

4 Amp Power Output

Field Selectable 12 or 24 VDC Output

Automatic Battery Charging Circuit

System Status LED Indicators

Fire Alarm Input

The 4204NX Power Supplies provide a field selectable 12 or 24 volt DC output. The required output voltage is accurately regulated to a fraction of a volt, even when operating under maximum load conditions. Output current is safely sustained while operating under heavy loads. The backup battery power instantaneously switches on upon loss of AC input. The 4204NX is UL listed for Access control under the UL294 standard.

### xFO FUSED POWER MODULE

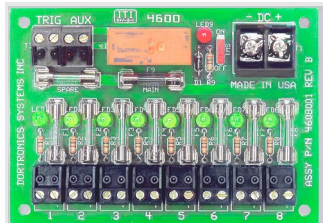

The standard xFO Fused Output module features a fused 4 amp input with eight (8) fused 1.6 amp outputs for power distribution to door locks or other low voltage security devices. The xFO/FAR unit includes a fire alarm interface relay to allow automatic power cut-off for installations with devices operating off of a single power supply. LED indicators are provided for "main power input" and each "fused output".

### 4000 SERIES 1 Amp PLUG IN SUPPLY



4012=12V 4024=24V

For smaller single door applications or accessories

Fused For protection

## 4500 AT & FT SERIES TIMER MODULES

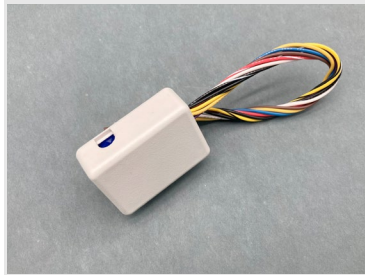

Adjustable 1 to 60 Second or Fixed 30 Second Time Delay

Compact Size

12/24 VDC Power

DPDT Relay Output

The AT timer is field adjustable to provide a delay time from 1 to 60 seconds. The FT timer has a fixed 30 second delay for code compliance. Both the AT and FT timers are packaged in a small plastic enclosure with flying leads.

## 4500 ET SERIES TIMER MODULES

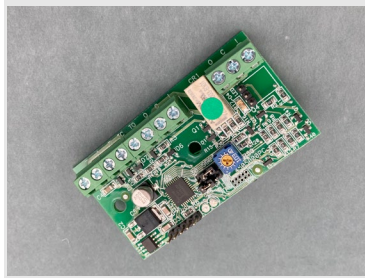

Adjustable 1 to 60 Second or set a Fixed 30 Second Time Delay

Compact Size

12/24 VDC Power

DPDT Relay Output

The ET timer is field adjustable to provide a delay time from 1 to 60 seconds. The ET timer has a terminal strip for field connections and will accept either a normally open or normally closed trigger input.

## 4300 SERIES 2 DOOR MANTRAP/INTERLOCK

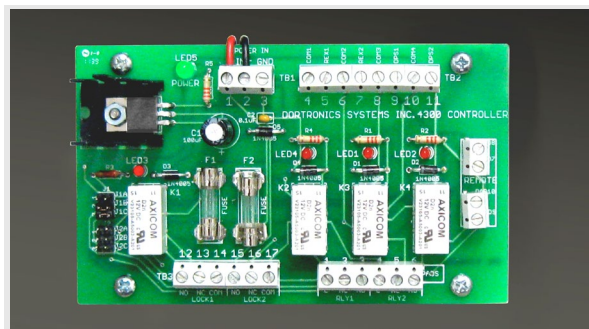

Economical Three Way Interlock Door Control

Environmental or Security Control

Access Control Compatible

Integral 12/24 VDC Power Supply

Panic or Remote Override Feature

The #4300 series door interlock controller provides a high level of access control and an economical solution for 2-door systems. It can be configured on site to control two normally locked doors, two normally unlocked doors or a locked, unlocked pair. Only one door may be accessed at a time. A request for access or an open door inhibits the other door which remains secure until the first door is closed and no request is pending. Suitable for 2-door air locks or security mantraps, both wet and dry output contacts are available for direct lock control and/or signaling requirements.

The 4300 is powered from the built-in UL 294 4 amp 12 or 24 VDC power supply to operate maglocks and/or strikes for each of the doors. The heavy-duty Class 2 power supply is ready for hook-up to the fire alarm system. An alarm output is also provided for monitoring the control system. The 4300 includes a provision for remote or panic override to force one or both doors open regardless of door status.

## 48500 2-5 DOOR USER CONFIGURED INTERLOCKS

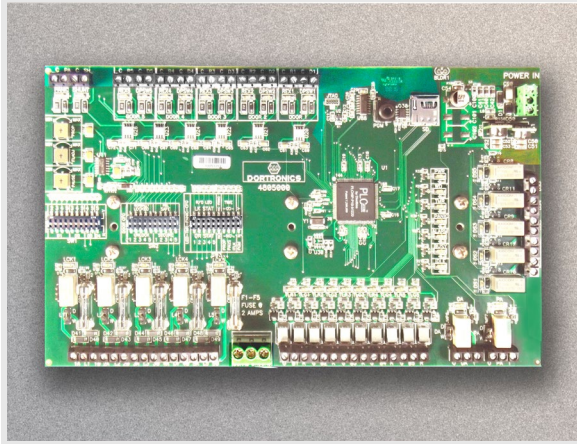

48500 Series Mantrap Control for up to 5 Locked or Unlocked Doors

12 Digital Inputs

5 Lock Relay Outputs

5 Door Status Outputs

10 LED Traffic Light Indicators (2) for each door

3 Onboard Adjustable timers for:  
Propped Door, Emergency Override Unlock Time & Request to Exit Unlock Time

### FIVE DOOR LOCKED EXAMPLE

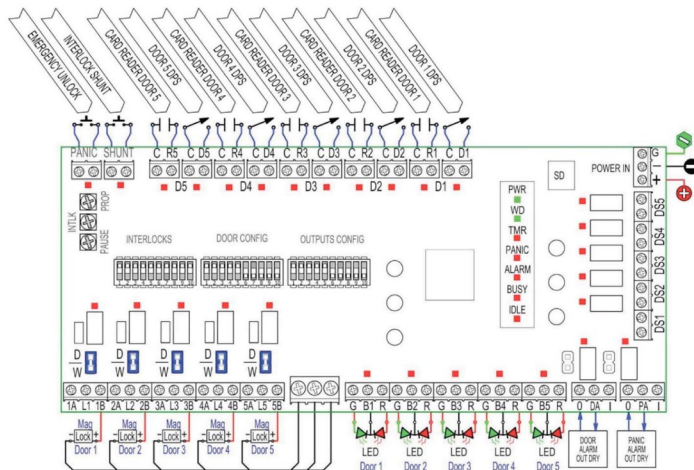

### Field Selectable Door Sequence & Functions

The 48500 PLC interlock controller is a cost effective method for operating door interlock and mantrap systems of up to five doors. The fully integrated controller is a one board solution that allows the installer complete control of all operating and configuration options without complex software.

Suitable for clean room air locks or security interlocks, with up to five normally locked or unlocked doors. This controller may be customized to control automatic door openers and provide custom timing and logic sequences for biological wash-down controls. Other provided outputs are for traffic lights, forced door alarms and an emergency panic release input.

The built-in UL Listed Class 2 power supply provides 12 or 24 VDC output for the PLC, Maglocks or Strikes & LED's.

## 48900 2-9 DOOR USER CONFIGURED INTERLOCKS

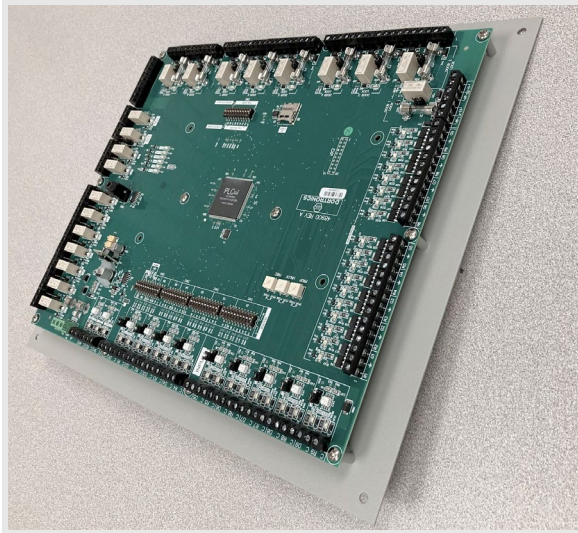

48900 Series Mantrap Control for up to 9 Locked or Unlocked Doors

20 Digital Inputs

9 Lock Relay Outputs

9 Door Status Outputs

18 LED Traffic Light Indicators (2) for each door

3 Onboard Adjustable timers for:  
Propped Door, Emergency Override Unlock Time & Request to Exit Unlock Time

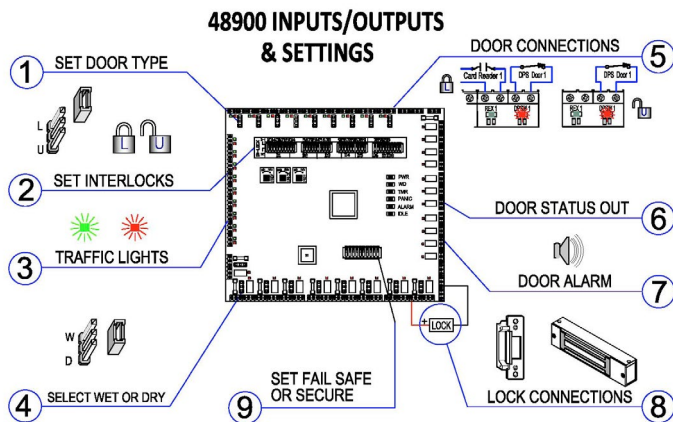

### Field Selectable Door Sequence & Functions

The 48900 PLC interlock controller is a cost effective method for operating door interlocks and systems of up to nine doors. The fully integrated controller is a one board solution that allows the installer complete control of all operating and configuration options without complex software.

Utilized for clean room air locks or security interlocks, with two to nine doors that are normally locked or unlocked. This controller may be customized to control automatic door openers and provide custom timing and logic sequences. This controller has outputs for traffic lights, door violation alarm and an emergency panic release input. The 48900 provides three individual timing sequences for, Propped Door Time, Emergency Override Unlock Time & Rex Unlock Time.

The built-in UL Listed Class 2 power supply provides 12 or 24 VDC output for the PLC, Maglocks or Strikes & LED's.

# 4900 SERIES INTERLOCKS & MANTRAP CONTROL

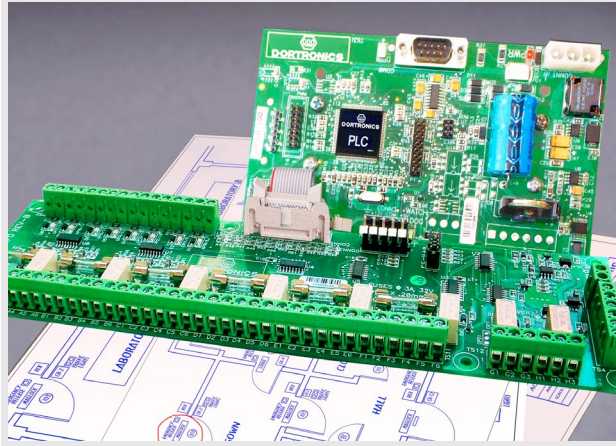

- 4900 Series Interlock Control for up to 120 Doors
- 8-Input / 4 Powered Outputs, 4 Relay Outputs
- Optional Relay Expansion Boards
- Optional Numerical Display
- Custom Sequencing & Timing Functions
- Traffic Light Control For User Feedback

Complex interlock systems are best handled with a PLC based controller. Dortronics PLC interlock controllers are the perfect Mantrap or Sallyport solution. The 4900 series is designed to handle larger systems with multiple rooms and doors.

These units can be factory programmed to control doors with automatic openers and provide custom timing and logic sequences for biological wash-down and air purging controls.

The built-in power supply provides a field selectable 12 or 24 VDC output for the PLC. This power can also operate the maglocks and/or strikes for the doors as well as LED indicators.

Suitable for air locks, clean room environments or security mantraps.



49311-L 3 Doors, 1 Room Locked Typical Wiring Shown

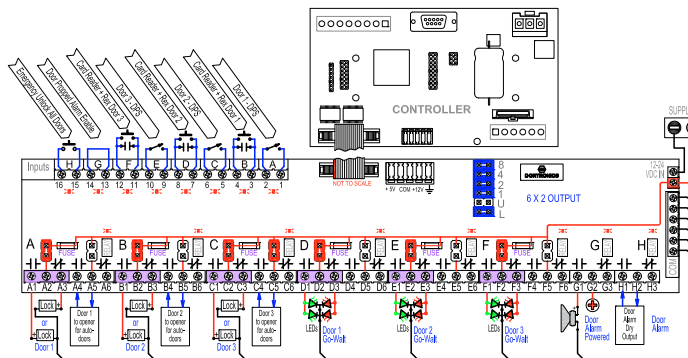



# WORKSHEET

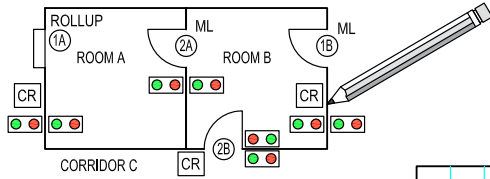

## STEP 1 SKETCH FLOOR PLAN

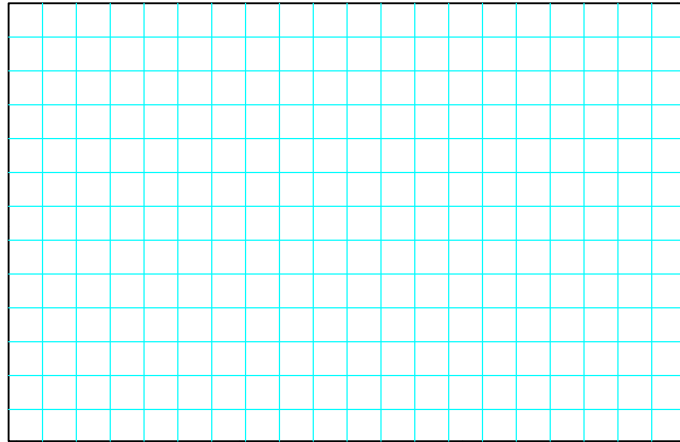

Show the number of doors and location. Note the type of lock to be used and identify each door. Doors that require access control to open, such as a card reader are considered normally locked. Doors that can be opened as long as interlocked doors are closed are considered normally unlocked.

Note if traffic lights are to be used and special requirements such as panic release buttons in or out of the mantrap.

### EXAMPLE ONLY

Door ID	Locked?	Interlocks	By	Access	FAIL	
1	101	Y	102, 103	Mag Lock	Card Read	Safe
2	102	N	101	Mag Lock	NA	Secure
3	103	N	101, 107, 110	Mag Lock	NA	Secure
4	107	Y	103, 110	Strike	Bio Read	Safe
5	110	N	103, 107	Auto Door	Pushbutton	Secure
6						
7						

## STEP 2 DOOR FUNCTIONS

Door ID	Locked?	Interlocks	By	Access	FAIL
1					
2					
3					
4					
5					
6					
7					

## 5140 SERIES KEY SWITCH CONTROLS

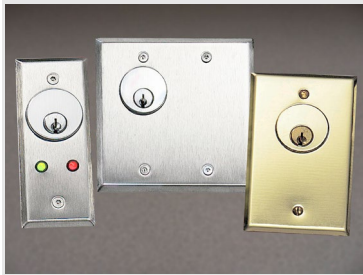

Standard 1-1/8" Mortised Cylinder

Narrow, Standard or Wide Switch Plates

Time Delayed Outputs  
DPDT Momentary or  
Alternate Action Contacts

The 5140 series switches allow activation by most cylinder cams. Single and double gang plates are available for wall mounting and a narrow plate is offered for metal door frames. Switch plates are furnished in satin finish stainless steel with optional LEDs to provide status indication. The optional sounder can be used with other control inputs to alert personnel of an alarm condition, authorized reset is then provided via the key switch.

## 5210 SERIES MUSHROOM KEY & RESET BUTTONS



1-9/16" or 2-3/8" Diameter Button

Momentary, Alternate Action or Time Delayed

Optional Latching with Key Reset Function

The 5210 request-to-exit controls are ideal for use in hospitals, industrial complexes, office buildings and institutions to release electric door locks.

Dual contact blocks, 1-NO & 1-NC, allow the magnetic lock power to be cut by the normally closed contacts while simultaneously signaling other systems with the normally open contact. Bi-Color LEDs are available for status indication.

## 5276 WR SERIES WATER PROOF SWITCHES



Suitable for Washdown IP65 Rated

Optional LED Indicator Ring

Heavy Duty Vandal proof  
Flush Mount Design

The WR5276 heavy duty stainless steel Switches are ideally suited for rooms that require washdown. They are rated IP65 to withstand spray from any angle. These units feature an optional red/green LED status ring which is independently controlled and ideal for indicating door or lock status. Control automatic doors, electric strikes or magnetic locks or use the DPST contacts as a (REX) input for an access control system.

## 5276 SERIES GUARDED BUTTONS



Guarded 1" Diameter

Alternate or Momentary  
Action DPST Contacts Also  
Available with a Pneumatic  
Time Delay

Narrow Mullion or Single  
Gang

The 5276-GP series Guarded push button switches are used reliably for release of electric door locks. The easy to operate, request-to-exit controls are suitable for use in high traffic conditions. Switches are furnished with a single gang plate or narrow mullion mounting. The plates are constructed of brushed stainless steel. Switch plates can also be engraved with standard or custom paint filled legends.

## 5277 SERIES PIEZOELECTRIC SWITCHES



Heavy Duty Stainless Steel Button and Plate  
LED Status Indicator  
Adjustable Time Delayed N.O. & N.C. Contacts  
Color Filled Engraving

The 5277-PZL stainless steel Piezo Switches are ideally suited for heavy usage applications. These units include a selectable red/green LED illumination status ring and an adjustable time delay of 1 to 60 seconds. Uses include control of automatic doors, electric strikes or magnetic locks or as a remote (REX) input of an access control system. The Touch Sensitive button has no moving parts. IP65 rated for washdown and outdoor applications.

## 5278 SERIES TOUCHLESS SWITCHES



Touchless Activation  
LED Ring Status Indicator  
Momentary Pulse DPDT Output  
Environmentally Sanitary

The 5278 series provides an economical solution for Touchless Ingress/Egress. The 5278 utilizes Optical Infrared Technology. The imbedded sensor picks up motion within a 4 inch range of the face plate. A simple wave of the hand activates the switch. The 5278 greatly decreases the potential to spread contagious diseases since no actual hand contact is required to activate.

## 5286 SERIES ARCHITECTURAL BUTTONS



Double, Single Gang or Narrow Mullion Plates  
Architectural Matched Finishes  
Standard or Custom Engraved Legends

Ideal for use where codes require a door control or electric lock release and an aesthetically pleasing appearance. The 5286 switches feature a large push plate, available in two sizes and three different back mounting plates to meet all installation requirements. Both the push plates and the mounting plates have smooth beveled edges on all four sides to enhance appearance. These assemblies are joined from the back with concealed screws.

## 5287 SERIES HEAVY DUTY BUTTONS



Impact Resistant Metal Construction  
Deflecting Guard Ring  
Easy Operating Actuator Button  
Hard Anodized Finish

Designed for hard use applications, the 5287 heavy duty push button is suited for installation in environments where it may be impacted by rolling carts or loaded warehouse wagons. Engineered to absorb direct force impact and deflect side blows, the pushbutton's rounded form also prevents snags on passing pedestrian traffic. The 5287 switch's 1-1/2" diameter solid aluminum button is housed in a protective beveled aluminum guard ring.

## 5230 & 5240 SERIES DESK CONSOLES



Under-Desk Mounting  
 Small Footprint, 5236 Unit  
 Measures 2-1/2" x 2" x 1"  
 Momentary, Toggle, or  
 Heavy Duty Metal Button  
 Optional LED Indicators

5230 series snap-action switches are designed for a reception desk or counter to provide remote operator control to multiple doors. The aluminum anodized unit can be easily under-desk mounted. The 5246 unit has a key switch locking mechanism to lock-out or override control of the buttons. The Optional Heavy Duty switches are DPDT and offer better performance under demanding conditions.

## 6400 SERIES PANIC & EGRESS BARS



Rim Mechanical Latch or  
 Signal Switch Bar  
 Contemporary Styling  
 with "Soft Touch" Action  
 Field Reversible Handing  
 2 Form C Switch Contacts

The 6495 series egress bar provides secure positive latching with a strong mechanical latch by utilizing a sintered steel latch bolt with an adjustable jamb mounted roller strike plate. These exit bars are intended for mounting on outward swinging doors for safe and reliable egress. Using minimum effort at any point along the active portion of the bar activates the mechanism in compliance with ADA criteria.

## 6450 SERIES LEVER TRIM FOR 6495



Field Selectable Handing  
 Utilizes Standard 1-1/8"  
 Mortise Cylinder  
 Aluminum or Dark Bronze  
 Finish  
 Attractive Slim Design

The 6450 series exterior lever handle trim mates with the 6495 series rim panic devices to allow mechanical latch retraction from the outside. The lever handle trim can be supplied from the factory with an optional mortise cylinder or will accept a standard cam 1-1/8" mortise cylinder supplied by others to be compatible with an existing building key system. Handing of the lever trim is field reversible for ease of installation.

## 6500 SERIES EMERGENCY PULL STATIONS



Highly Visible in Black,  
 Blue, or Yellow  
 Emergency Door Release  
 Deters Unauthorized Entry  
 and Exit  
 Dual Switch Contacts

Emergency Pull Stations are stocked in black, yellow and blue to clearly differentiate them from traditional "red" fire alarm stations. These door pull stations mount to 1-gang box. Also offered with matching color back box. The 6510 can be reset with a supplied key and by replacing the unit's acrylic break rod (1 supplied per unit for tamper detection).

## 7100 SERIES DELAYED EGRESS



Conforms to NFPA 101 and BOCA Codes

On Board Clock/Calendar

15 or 30 Second Delay

Built-in Keypad Access Control

The EDR System-101 controller activates an audible warning on an exit attempt. After a three second warning, if the exit sensor continues active, the irreversible unlocking sequence is started in accordance with NFPA 101 code. The 15 or 30 seconds delay, before the door unlocks, is programmable. Door armed and door unlocked intervals can be scheduled by time of day and by the day of the week to comply with site requirements.

## 7201 SERIES HI-INTENSITY LEDS

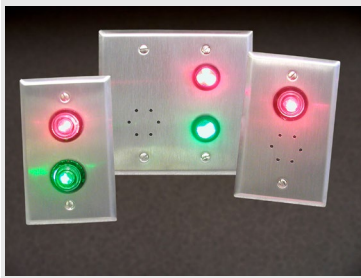

Highly Visible Daylight Viewing

Sealed for Exterior or Interior Applications

Long Lasting & Durable

Optional Piezo Sounder

7201 Series High Intensity LED Indicators are available in a variety of configurations for outdoor and indoor use. Weatherproof High Intensity LEDs & Piezo sounders are supplied on a gasketed plate for exterior applications. Basic units feature high intensity red and green LEDs on a single plate for mounting in a standard electrical box to interface with virtually any type of access control system.

## 7200 SERIES CUSTOM MULTI ZONE ANNUNCIATORS

Built to your Specifications

Custom 2, 3, or 4 gang Plates with LEDs, Switches, or Piezo sounders

Pushbuttons or Toggles  
Choice of Momentary or Maintained



Customized 19" Rack Mount Panels

Aluminum or Stainless Steel Console Panels with Custom Engraved Legends

Sloped Desktop Enclosures Available

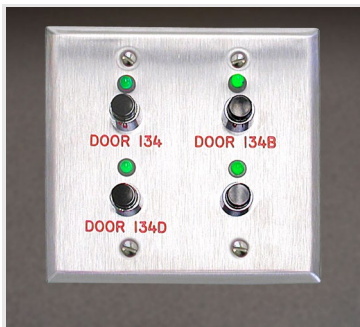

The 7200 series Console Panels can be manufactured to provide a unique combination of LEDs and switches to control or interface with other security systems. Applications include security stations, remote door control, nursing stations in medical and retirement facilities. Choose from a selection of push buttons or toggle switches, LED's, Key switches, & sounders for a console fully customized and tailored to meet your needs.



## 7281 & 7286 SERIES EXIT ALARMS

The 7281-EA Exit Alarm can monitor emergency exit doors, with an immediate alarm whenever the door is opened – even if the door is immediately re-closed. This alarm is also configurable as a door prop alarm. The delay timer is field adjustable from 2 to 60 seconds.

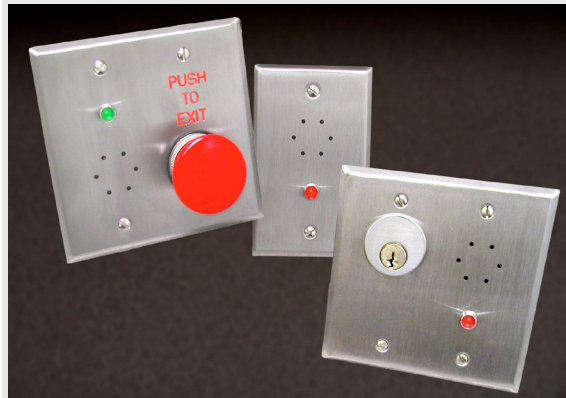

The 7286-PT Prop Timer has LEDs to indicate door status, low voltage DC power to operate the locking device and a mirrored door switch output. A signal from an access control panel prompts the alarm to unlock the door. The door open time, and the local warning time are adjustable.

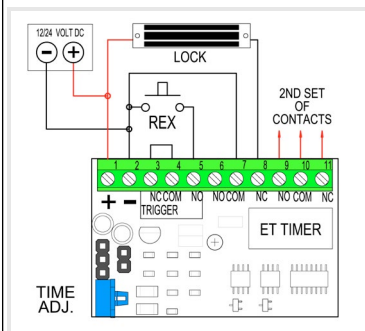

- Local Exit Alarm or Door Prop Alarm
- Door / Alarm LED Status Indicators
- Adjustable Door Open & Alarm Warning Time
- Manual & Automatic Reset
- Optional Key Switch Reset / By-pass

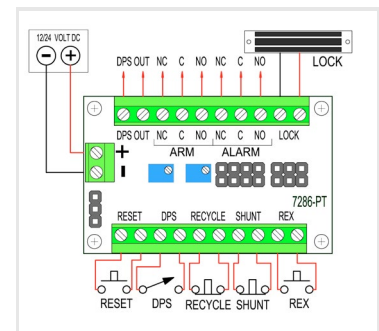

## 7600 SERIES MULTI ZONE ANNUNCIATORS

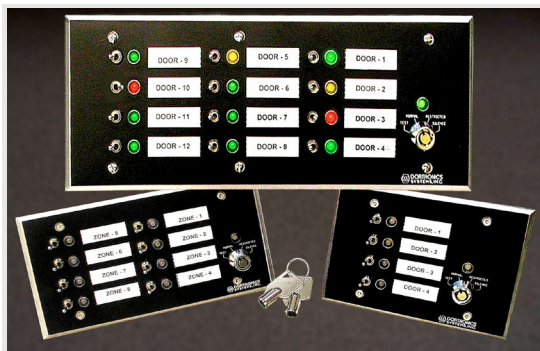

- Monitor & Control 100+ Doors or Zones
- Tri-state LEDs Indicate Security Status
- Built-in Piezo Alarm Sounder
- Shunt Zones & Lock/Unlock Doors
- Override and Acknowledge Alarms
- Multiple Operators / Control Panels

The 7600 series Annunciator/Controller system, is expandable in four zone increments to provide monitoring and control of over 100 doors/zones. These panels are available for console, flush or rack mounting. They feature tri-state LEDs for each zone to visually indicate when a door is: closed and locked; closed and unlocked; opened with authorization; forced or held open; and when an alarm has been sounded.

Doors can be remotely unlocked to allow access using the 7600 Annunciator. Function of the switches and Piezo alarm sounder is selectable by the on board Keyswitch. When used with DORTRONICS 7101 Delayed Egress System, the status of each door is displayed on the panel and unauthorized exit attempts are reported as alarms. This device can also monitor the 7200 series Door Prop Alarms to alert security when a door is unsecured or monitor ingress and egress through an independent access control system or by manual station control hardware such as a key or keypad.

## CUSTOM CAPABILITIES

Turn concepts into reality with our custom design capabilities

If you can't find exactly what you are looking for, we can build it to your specifications. We stock a wide variety of components, accessories and mounting hardware in many finishes. We also offer quick turnaround for custom control panels, & arrays. Customized switches are constructed with your choice of contact configuration, finish & engraving. Mounting, power consumption, size and holding force can all be designed into a custom Electromagnet for your unique application. We have a solution for your special finish, engraving, function, mounting, or logic requirements.

Over the years we have acquired a solid reputation for being able to listen well and respond quickly.

## CUSTOM PANELS



Control, Doors, Gates  
Mantraps, & Sallyports

Designed to fit your  
requirements

Specify the configuration  
& we'll build it

Used in government, medical, law enforcement and detention facilities, custom control panels & consoles are constructed using any combination of heavy duty switches, audible sounders and LED indicators. Components can include relays, intelligent logic or simply wire leads. CAD is used both for design and fabrication of these high security panels where quality, reliability and durability are critical.

## CUSTOM SWITCHES



Built to your Function &  
Finish requirements

Match existing hardware  
or create your own

Unlimited Design Options

Special purpose switch plates can be custom engraved to the customer's specification. Switch plates and actuating touch pads can be finished to match most architectural requirements.

Our customized switches can be used in wash-down areas, prisons, food preparation rooms, and high security locations. We can also build special timing or sequenced operations into these devices.

## CUSTOM MAGNETS



Industrial and commercial  
uses

A variety of holding  
strengths 25 to 1500lbs

Fast development &  
turnaround time

Electromagnets are utilized in many diverse applications. Security, equipment safety interlocks, fabrication work holders, storage cabinet & drawer locking and ATM enclosures are some examples of uses. With our in-house manufacturing capabilities, DORTRONICS can build electromagnets of any size, voltage or holding force required. We can also supply custom wiring harnesses and connectors for unique applications.

## ***LUNCH AND LEARN (Online or In-Person) MULTIDOOR INTERLOCKS***

As North America's most experienced manufacturer of multi-door interlocking solutions, Dortronics welcomes the opportunity to educate Architects, Engineers and Specifiers.

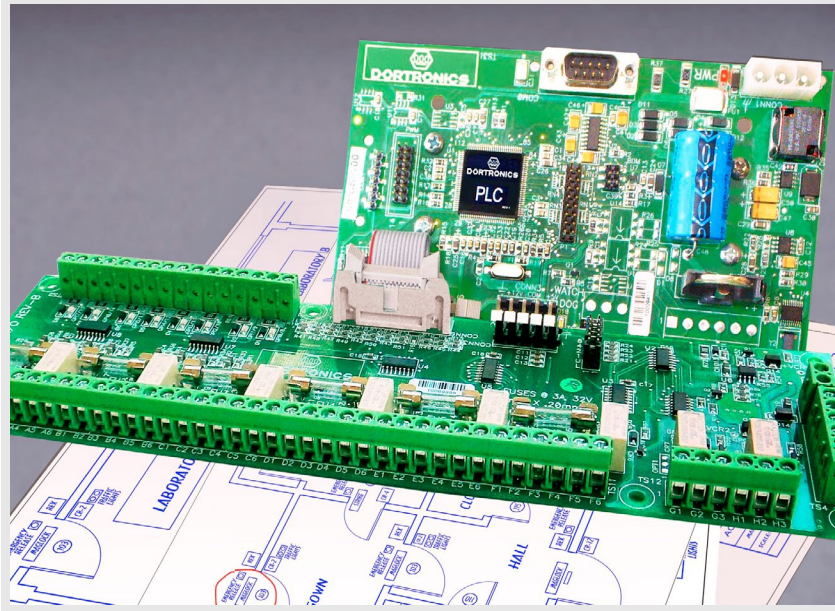

### **Door Interlocks: Application and System Design**

AIA Course DSI AIA.24 IL

BICSI Course OV-DOR-NY-1024-2

In this one-hour AIA and BICSI recognized course we will review the various types of door interlocks, Mantraps, Sallyports and their applications.

The course may be taken online, or arranged at your facility where we will provide lunch and the one hour course for your group. Upon completion attendees will receive a certificate for:  
1 AIA learning unit, LU/HSW and/or 1 BICSI CEC.

[Contact us](#) to schedule.



## **LUNCH AND LEARN (Online or In-Person) ELECTRONIC LOCKING DEVICES**

A premier US based manufacturer of Electronic locks and door control solutions, Dortronics welcomes the opportunity to educate Architects, Engineers and Specifiers

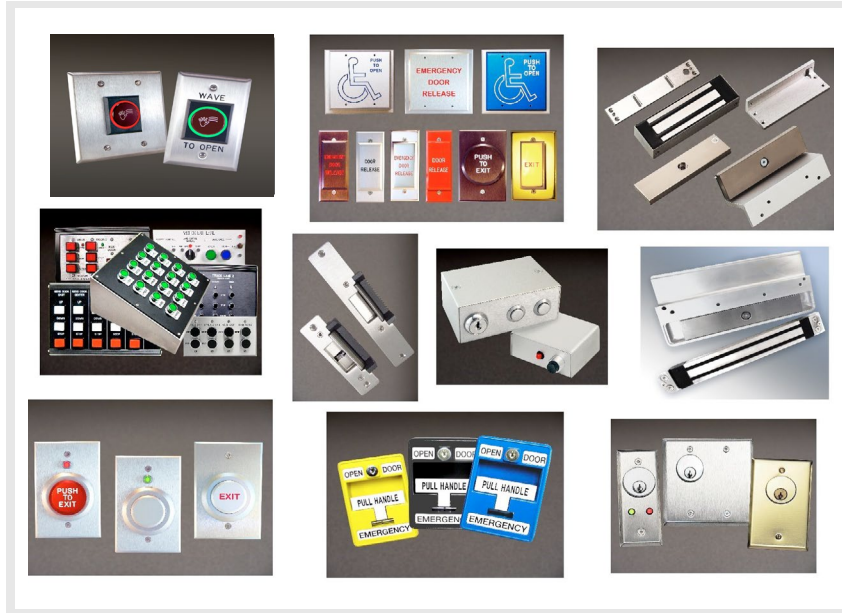

### **Electronic Locking Devices: For use with Access Control Systems**

AIA Course DSI AIA.24 HW

BICSI Course OV-DOR-NY-1024-1

In this one-hour AIA and BICSI recognized course we will review various types of Electronic door locks, their applications and accessory devices to control them.

The course may be taken online, or arranged at your facility where we will provide lunch and the one hour course for your group. Upon completion attendees will receive a certificate for:  
1 AIA learning unit, LU/HSW and/or 1 BICSI CEC.

[Contact us](#) to schedule.



## DORTRONICS SYSTEMS, INC.

A division of SAG HARBOR INDUSTRIES

*Driven by a new product development and customer services*

Charles Edison, the son of inventor Thomas Edison, founded Sag Harbor Industries in 1946. Sag Harbor Industries is a contract manufacturer of custom electronic assemblies. Products manufactured in the Sag Harbor, NY and Farmville, NC facilities include motor windings, solenoids, stators, voice coils for headsets and printed circuit board assemblies. Satellite communication gear and Medical sub-assemblies are also produced in a controlled environment.

In 1989, Sag Harbor began producing electromagnetic locks for Dortronics Systems. Dortronics Systems was purchased and became a wholly owned subsidiary of Sag Harbor Industries in 1990. Dortronics Systems operates out of the Sag Harbor Industries facility on Long Island and manufactures electric locking hardware and controls for the Security, Hardware, and Door control industries.



*We proudly stand behind every one of our products through our customer service, product dependability, and Quality product warranty.*



***WHAT YOU WANT - WHEN YOU WANT IT***



**DORTRONICS**  
**SYSTEMS, INC.**



Made with pride



1668 SAG HARBOR TURNPIKE, SAG HARBOR, NY 11963

www.dortronics.com • p (800) 906-0137 • f (631) 725-0505 • sales@dortronics.com