



PRICE LIST - MARCH 2024

	<u>PAGE #</u>
1000 SERIES ELECTROMAGNETIC LOCKS	
#MM300 - MINI-MAGNETIC LOCKS - CABINETS/DRAWERS	2
#1000 - INDUSTRIAL MAGNETIC LOCKS & ACCESSORIES	2
#1100 - MAGNETIC LOCKS - OUTSWING DOORS/ DELAYED EGRESS	3
#ML1100 - MORTISED MAGNETIC LOCKS & PULLS	3
#TJ1100 - MAGNETIC LOCKS - INSWING DOORS/ DELAYED EGRESS	4
#1100 - MAGNETIC LOCK - OPTIONS & CUSTOM HOUSINGS	5
#1100 - MAGNETIC LOCK - SPECIAL FINISHES	6
#1180 - MAGNETIC LOCK - FILLER PLATES	7
#1180 - MAGNETIC LOCK - FILLER PLATE-SPECIAL FINISHES	8
#1190 - MAGNETIC LOCK - ANGLE MOUNTING BRACKETS	9
#1190 - MAGNETIC LOCK - ANGLE MOUNTING BRACKET FINISHES	10
#1190 - MAGNETIC LOCK - Z-BRACKET SPACER BLOCKS	11
#1190 - ARMATURE MOUNTING BRACKETS-HERCULITE BRACKETS	12
3000 SERIES ELECTRIC STRIKES	
#3300 - ANSI STYLE STRIKES	13
4000 SERIES POWER SUPPLIES & CONTROLLERS	
#4000 - PLUG-IN POWER SUPPLIES	14
#4200 - POWER SUPPLIES	14
#4300 - ECONOMY MANTRAPS / INTERLOCKS 2 - DOORS	15
#48500 - FIELD PROGRAMMABLE INTERLOCKS (replaces 4700 series)	16
#48900 - FIELD PROGRAMMABLE INTERLOCKS	17
#4900 - PLC MANTRAPS / INTERLOCKS UP TO 120 DOORS	18
5000 SERIES ACTUATING CONTROLS	
#5100 - MORTISE KEY SWITCHES	19
#5210 - PUSH BUTTON SWITCHES ROUND	20
#5215 - PUSH BUTTON SWITCHES SQUARE	21
#5230 - SNAP ACTION PUSH BUTTONS / UNDER DESK CONSOLES	22
#5240 - ELECTRIC KEY SWITCHES / UNDER DESK CONSOLES	23
#5260 - RECTANGULAR PUSH BUTTON SWITCHES	24
#5276 - SWITCHES GUARDED / HEAVY DUTY & WATERPROOF	25 & 26
#5277 - PIEZOELECTRIC SWITCHES	27
#5278 - TOUCHLESS ELECTRIC SWITCHES	27
#5286 - PUSH PLATE SWITCHES	28, 29, 30
#5287 - HEAVY DUTY PUSH BUTTON SWITCHES	31
6000 SERIES ACCESSORIES	
#6220 - DOOR CORDS	32
#6420 - PANIC EGRESS BARS	32
#6450 - LEVER TRIM DEVICE FOR PANIC EGRESS BARS	32
#6500 - EMERGENCY PULL STATIONS & ANTI TAMPER COVERS	33
#6612 - REX MOTION DETECTORS	33
7000 SERIES ANNUNCIATORS	
#7101 - DELAYED EGRESS SYSTEM	34
#7201 - HI-INTENSITY LED INDICATORS & PIEZO SOUNDERS	35
#7200 - MULTI-ZONE ANNUNCIATORS	36
#7281 - DOOR EXIT ALARM / ANNUNCIATORS	37
#7286 - DOOR PROP ALARM / ANNUNCIATORS	38
#7600 - MULTI-ZONE ANNUNCIATOR / CONTROLLERS	39
#7600 - ANNUNCIATOR PANEL & RACK SIZE INFORMATION	40
8000 SERIES ACCESS CONTROL SYSTEMS	
#8100 - KEYPAD ACCESS CONTROL	41
REPAIR PARTS & MISCELLANEOUS	
#1100 - ELECTROMAGNETIC LOCK PARTS	42
#5000 - ACTUATING CONTROL SWITCH PARTS	43
ELECTRICAL BOXES & ACCESSORIES	43
SALES POLICIES & CREDIT APPLICATION	44 & 46



MAGNETIC LOCKS

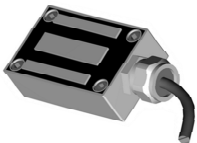
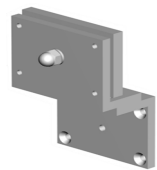

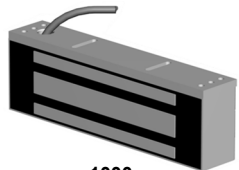
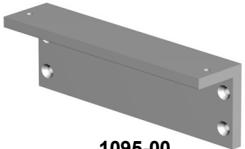
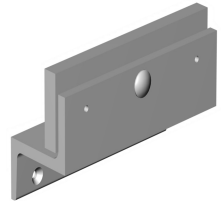
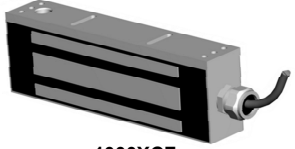
	<u>PART #</u>	<u>DESCRIPTION</u>	<u>LIST PRICE</u>
MINI SERIES	CABINET & DRAWER LOCKS		
	MM-300	<u>MINI-MITE LOCK</u> 300 LB MINI-MITE LOCK 12/24 VDC (DUAL VOLTAGE) WITH STAINLESS STEEL HOUSING (3-1/4" x 2-1/4" x 1-3/4" OVERALL)	\$325.00
MM-300	TJMM-300	FOR INSWING APPLICATIONS INCLUDES Z-BRACKET	\$430.00
	MM-D1 MM-D2 MM-ZD1	ACCESSORY ARMATURE ANGLE BRACKET TJ BACK MOUNTING BRACKET MINI MITE Z- BRACKET	\$70.00 \$70.00 \$125.00
MM-ZD1			

MM-300N	1000 SERIES INDUSTRIAL ELECTROMAGNETIC LOCKS		
	1000	<u>INDUSTRIAL LOCK - OUTSWING DOORS</u> 1200 LB LOCK 12/24 VDC (DUAL VOLTAGE - FIELD SELECTABLE) FOR SURFACE MOUNTING ON OUTSWING DOORS STAINLESS STEEL HOUSING	\$750.00
1000	TJ-1000	1200 LB LOCK 12/24 VDC (DUAL VOLTAGE - FIELD SELECTABLE) FOR SURFACE MOUNTING ON INSWING DOORS INCLUDES ANGLE MOUNTING BRACKET AND ARMATURE "Z" BRACKET	\$830.00
	1095-00	<u>OPTIONAL MOUNTING BRACKET</u> USE FOR GATE OR SLIDING DOOR APPLICATIONS	\$90.00
1095-00	1099-00	<u>GATE/INSWING - CONVERSION KIT</u> KIT INCLUDES 1095-00 ANGLE BRACKET & 1096-00 Z- BRACKET FOR MOUNTING OF CONDUIT FITTED LOCKS OR TOP JAMB MOUNTING (IN-SWING DOORS) OF STANDARD INDUSTRIAL LOCK (KIT INCLUDED WITH TJ-1000)	\$234.00
	1096-00 Z-BRACKET		
	xD xCF	ADD SPDT DOOR POSITION SWITCH ADD CONDUIT FITTING (FOR 1/2" RIGID CONDUIT) (THE 1000XCF COMES WITH 10' LEADS)	\$75.00 \$45.00
1000XCF			

FILLER PLATES & ANGLE BRACKETS pgs. 8-12

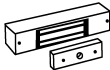

MAGNETIC LOCKS

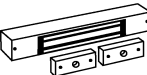
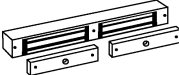
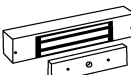
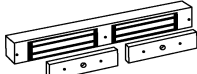
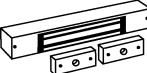
	<u>PART #</u>	<u>DESCRIPTION</u>	<u>LIST PRICE</u>
1100 SERIES	ELECTROMAGNETIC LOCKS		
	1107	600LB DELAYED EGRESS ACTUATING LOCK NARROW 600 LB LOCK 12/24 VDC DUAL VOLTAGE **ADD xD or xEDR OPTIONS ONLY - NO FINISHES**	\$560.00
	1110	1200 LB SINGLE MAGLOCK SINGLE DOOR 1200 LB LOCK 12/24 VDC (DUAL VOLTAGE - FIELD SELECTABLE)	\$700.00
	1115	600 LB SPLIT ARMATURE MAGLOCK SPLIT ARMATURE DOUBLE LOCK 12/24 VDC (DUAL VOLTAGE - FIELD SELECTABLE)	\$740.00
	1120	1200 LB DOUBLE MAGLOCK DOUBLE DOOR 1200 LB 12/24 VDC (DUAL VOLTAGE - FIELD SELECTABLE)	\$1,400.00
	1150	1500 LB SINGLE MAGLOCK SINGLE DOOR 1500 LB 12/24 VDC (DUAL VOLTAGE - FIELD SELECTABLE)	\$760.00
	1152	1500 LB DOUBLE MAGLOCK DOUBLE DOOR 1500 LB 12/24 VDC (DUAL VOLTAGE - FIELD SELECTABLE)	\$1,520.00
	1155	750 LB SPLIT ARMATURE MAGLOCK SPLIT ARMATURE DOUBLE LOCK 12/24 VDC (DUAL VOLTAGE - FIELD SELECTABLE)	\$795.00

1100 SERIES MORTISED LOCK APPLICATIONS

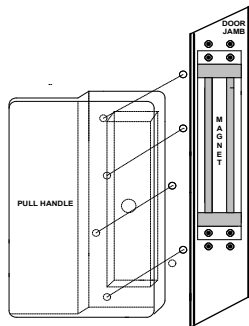

ML-1100	MORTISED MAGLOCKS MORTISED 1000 LB LOCK INCLUDES RECESSED MOUNTING BRACKET & ARMATURE 24 VDC ONLY	\$800.00
DPA1100	ALUMINUM DOOR PULLS DOOR PULL FOR #ML-1100 MORTISED LOCK	\$500.00
(SUFFIX) XDBA	<i>If DPA pull & ML lock are ordered together the armature will be factory mounted in the DPA pull</i> FOR DARK BRONZE ANODIZED FINISH PULL OTHER FINISHES AVAILABLE CHECK WITH FACTORY	ADD \$280.00

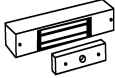
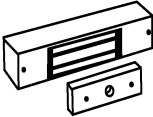
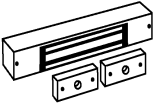
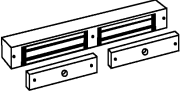
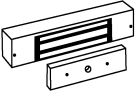
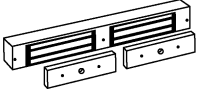
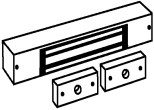
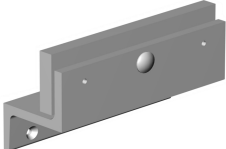
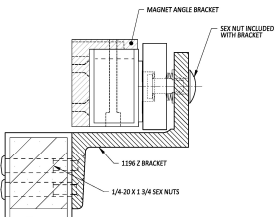

MAGNETIC LOCKS

	<u>PART #</u>	<u>DESCRIPTION</u>	<u>LIST PRICE</u>
TJ1100 SERIES IN-SWINGING DOOR APPLICATIONS			
	TJ1107	600LB DELAYED EGRESS ACTUATING LOCK NARROW 600 LB LOCK 12/24 VDC (DUAL VOLTAGE, INCLUDES Z-BRACKET FOR ARMATURE) **ADD <u>xD or xEDR OPTIONS ONLY - NO FINISHES**</u>	\$740.00
	TJ1110	1200 LB SINGLE MAGLOCK SINGLE DOOR 1200 LB LOCK 12/24 VDC (DUAL VOLTAGE - FIELD SELECTABLE, INCLUDES TOP JAMB LOCK HOUSING w/ Z-BRACKET FOR ARMATURE)	\$890.00
	TJ1115	600 LB SPLIT ARMATURE MAGLOCK SPLIT ARMATURE DOUBLE LOCK 12/24 (DUAL VOLTAGE - FIELD SELECTABLE, INCLUDES TOP JAMB LOCK HOUSING w/ Z-BRACKET FOR ARMATURE)	\$875.00
	TJ1120	1200 LB DOUBLE MAGLOCK DOUBLE DOOR 1200 LB 12/24 (DUAL VOLTAGE - FIELD SELECTABLE, INCLUDES TOP JAMB LOCK HOUSING w/ Z-BRACKET FOR ARMATURE)	\$1,780.00
	TJ1150	1500 LB SINGLE MAGLOCK SINGLE DOOR 1500 LB 12/24 (DUAL VOLTAGE - FIELD SELECTABLE, INCLUDES TOP JAMB LOCK HOUSING w/ Z-BRACKET FOR ARMATURE)	\$1,000.00
	TJ1152	1500 LB DOUBLE MAGLOCK DOUBLE DOOR 1500 LB 12/24 (DUAL VOLTAGE - FIELD SELECTABLE, INCLUDES TOP JAMB LOCK HOUSING w/ Z-BRACKET FOR ARMATURE)	\$2,000.00
	TJ1155	750 LB SPLIT ARMATURE MAGLOCK SPLIT ARMATURE DOUBLE LOCK 12/24 (DUAL VOLTAGE - FIELD SELECTABLE, INCLUDES TOP JAMB LOCK HOUSING w/ Z-BRACKET FOR ARMATURE)	\$1,200.00
		TYPICAL Z-BRACKET FOR MOUNTING ARMATURE INCLUDED WITH EACH TOP JAMB LOCK SEE PAGE 42 FOR Z-BRACKET PRICING AS A SPARE PART ONLY (ALL TJ LOCKS INCLUDE A Z-BRACKET)	
	1095-07	1107 SERIES INSWING - CONVERSION KIT KIT INCLUDES 1107302 ANGLE BRACKET & 1196-06 Z-BRACKET FOR TOP JAMB MOUNTING (IN-SWING DOORS) (KIT INCLUDED WITH TJ1107)	\$270.00
	1095-07XEDR	1107xEDR SERIES INSWING - CONV. KIT KIT INCLUDES 1107301 ANGLE BRACKET, 1196-06 Z-BRACKET W/SHIM & SPRING LOADED PLATE FOR TOP JAMB MOUNTING (KIT INCLUDED WITH TJ1107xEDR)	\$350.00



MAGNETIC LOCKS

1100 SERIES	PART #	DESCRIPTION	LIST PRICE
		OPTIONAL MAGNETIC LOCK FEATURES	
	<u>(SUFFIX)</u>	<u>1100 SERIES OPTIONS (ADD TO LOCK):</u>	<u>(ADD)</u>
	xL	ADD 1 LED (BICOLOR RED / GREEN)	\$44.00
	xD	ADD SPDT DOOR POSITION SWITCH (SINGLE)	\$70.00
	x2D	ADD 2 SPDT DOOR POSITION SWITCHES (1115/1120/1152/1155)	\$140.00
	XDD	ADD DPDT DOOR POSITION SWITCH (NOT AVAILABLE FOR 1000 SERIES)	\$140.00
	xB	ADD 1 MAGNETIC BOND SENSOR (NOT AVAILABLE FOR 1000,1115,1155 SERIES LOCKS)	\$140.00
	x2B	ADD 2 MAGNETIC BOND SENSORS DOUBLE(1120/1152)	\$280.00
	xCF	ADD CONDUIT FITTING (FOR 1/2" RIGID CONDUIT) (1000XCF HAS 10' LEADS, NOT AVAILABLE FOR 1107)	\$20.00 \$45.00
	xCT	ADD COVER TAMPER SWITCH	\$65.00
	xTS	ADD TAMPER RESISTANT SCREWS/DRIVER	\$30.00
		ONLY AVAILABLE WITH 1107 & 1110 SERIES	
	xEDR	ADD ATTEMPTED EGRESS SWITCH & DOOR SWITCH w/ ARMATURE MOUNTING ASSEMBLY (FOR SINGLE DOOR w/ EDR SYSTEM-101)	\$270.00
	xEDR-C	SAME AS ABOVE WITH 15' MULTICONDUCTOR LEADS	\$370.00
	xEDR-C-WR	SAME AS ABOVE WITH WEATHER RESISTANT SWITCH	\$400.00
		<u>FULL WIDTH HOUSINGS (ADD TO LOCK):</u>	<u>(ADD)</u>
	LW-	ADD TO 1106/1110/1150 MAGLOCK FOR SINGLE LOCK HOUSINGS UP TO 48" WIDE	\$700.00
	LW-	ADD TO 1115/1120/1152 MAGLOCK FOR DOUBLE LOCK HOUSINGS UP TO 72" WIDE	\$800.00
		<u>FULL HEIGHT HOUSINGS (ADD TO LOCK):</u>	<u>(ADD)</u>
	LV-	ADD TO 1106/1110/1150 MAGLOCK - FOR SINGLE LOCK HOUSINGS UP TO 96" LONG	\$750.00
	LV-	ADD TO 1120/1152 MAGLOCK - FOR DOUBLE LOCK HOUSINGS UP TO 96" LONG	\$850.00
		FOR OTHER CUSTOM LOCKS OR HOUSINGS (CALL FOR QUOTE)	
		FOR CUSTOM FINISHES (CALL FOR QUOTE)	

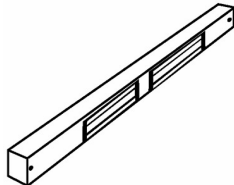



MAGNETIC LOCKS

1100 SERIES	<u>PART #</u>	<u>DESCRIPTION</u>	<u>LIST PRICE</u>
		OPTIONAL SPECIAL LOCK FINISHES	
	<u>(SUFFIX)</u>	<u>ANODIZING (ADD TO LOCK PRICE):</u>	
	xDBA	DARK BRONZE ANODIZE (US10D) -	<u>(ADD)</u>
		1107 SERIES ANODIZING NOT OFFERED	N/A
		ADD FOR 1110 , 1115 SINGLE SERIES	\$140.00
		ADD FOR 1120 DOUBLE SERIES	\$240.00
		ADD FOR 1150, 1155 SINGLE SERIES	\$140.00
		ADD FOR 1152 DOUBLE SERIES	\$260.00
		ADD FOR TJ1110, TJ1115 TOP JAMB SINGLE	\$170.00
		ADD FOR TJ1120 TOP JAMB DOUBLE	\$300.00
		ADD FOR TJ1150, TJ1155 TOP JAMB SINGLE	\$190.00
		ADD FOR TJ1152 TOP JAMB DOUBLE	\$340.00
	<u>(SUFFIX)</u>	<u>PLATING (ADD TO LOCK PRICE):</u>	
	XUS26	POLISHED CHROME -	
	XUS26D	SATIN CHROME -	
	XUS3	POLISHED BRASS -	<u>(ADD)</u>
	XUS4	SATIN BRASS -	
		1107 SERIES PLATING NOT OFFERED	N/A
		ADD FOR 1110 , 1115 SINGLE SERIES	\$680.00
		ADD FOR 1120 DOUBLE SERIES	\$800.00
		ADD FOR 1150, 1155 SINGLE SERIES	\$690.00
		ADD FOR 1152 DOUBLE SERIES	\$820.00
		ADD FOR TJ1110,TJ1115 TOP JAMB SINGLE	\$880.00
		ADD FOR TJ1120 TOP JAMB DOUBLE	\$1,120.00
		ADD FOR TJ1150, TJ1155 TOP JAMB SINGLE	\$890.00
		ADD FOR TJ1152 TOP JAMB DOUBLE	\$1,140.00



MAGNETIC LOCKS

1180 SERIES	PART #	DESCRIPTION	LIST PRICE
	FILLER PLATES		
	3/8" FILLERS		
	1183-00	3/8 x1" 1000 SERIES FILLER 8-1/4" LONG	\$33.00
	1183-07	3/8 x1-1/4" 1107 SERIES FILLER 8-1/4" LONG	\$56.00
	1183-10	3/8 x1" 1110/1115 SERIES FILLER 12-1/2" LONG	\$45.00
	1183-20	3/8 x1" 1120 SERIES FILLER 23" LONG	\$53.00
	1183-50	3/8 x1" 1150/1155 SERIES FILLER 12" LONG	\$45.00
	1183-52	3/8 x1" 1152 SERIES FILLER 24" LONG	\$56.00
	EXTRA WIDE FILLER PLATES		
	1183-00-W	EXTRA WIDE 3/8 x 1-1/2" 1000 FILLER 8-1/4" LONG	\$41.00
	1183-10-W	EXTRA WIDE 3/8 x 1-3/4" 1110/1115 FILLER 12-1/2" LONG	\$53.00
	1183-20-W	EXTRA WIDE 3/8 x 1-3/4" 1120 FILLER 23" LONG	\$64.00
	1183-50-W	EXTRA WIDE 3/8 x 2" 1150/1155 FILLER 12"	\$53.00
	1183-52-W	EXTRA WIDE 3/8 x 2" 1150/1155 FILLER 24"	\$64.00
	1/2" FILLERS		
	1184-00	1/2"x1" 1000 SERIES FILLER 8-1/4" LONG	\$37.00
	1184-07	1/2 x1-1/4" 1107 SERIES FILLER 8-1/4" LONG	\$60.00
	1184-10	1/2"x1" 1110/1115 SERIES FILLER 12-1/2" LONG	\$47.00
	1184-20	1/2"x1" 1120 SERIES FILLER 23" LONG	\$60.00
	1184-50	1/2"x1" 1150/1155 SERIES FILLER 12" LONG	\$47.00
	1184-52	1/2"x1" 1152 SERIES FILLER 24" LONG	\$60.00
	EXTRA WIDE FILLER PLATES		
	1184-00-W	EXTRA WIDE 1/2 x 1-1/2" 1000 FILLER 8-1/4" LONG	\$47.00
	1184-10-W	EXTRA WIDE 1/2 x 1-3/4" 1110/1115 FILLER 12-1/2"	\$57.00
	1184-20-W	EXTRA WIDE 1/2 x 1-3/4" 1120 FILLER 23" LONG	\$70.00
	1184-50-W	EXTRA WIDE 1/2 x 2" 1150/1155 FILLER 12" LONG	\$57.00
	1184-52-W	EXTRA WIDE 1/2 x 2" 1152 FILLER 24" LONG	\$70.00
	5/8" FILLERS		
	1185-00	5/8"x1" 1000 SERIES FILLER 8-1/4" LONG	\$41.00
	1185-07	5/8 x1-1/4" 1107 SERIES FILLER 8-1/4" LONG	\$64.00
	1185-10	5/8"x1" 1110/1115 FILLER 12-1/2" LONG	\$49.00
	1185-20	5/8"x1" 1120 SERIES FILLER 23" LONG	\$64.00
	1185-50	5/8"x1" 1150/1155 SERIES FILLER 12" LONG	\$50.00
	1185-52	5/8"x1" 1152 SERIES FILLER 24" LONG	\$64.00
	EXTRA WIDE FILLER PLATES		
	1185-00-W	EXTRA WIDE 5/8 x 1-1/2" 1000 FILLER 8-1/4" LONG	\$53.00
	1185-10-W	EXTRA WIDE 5/8 x 1-3/4" 1110 FILLER 12-1/2" LONG	\$61.00
	1185-20-W	EXTRA WIDE 5/8 x 1-3/4" 1120 FILLER 23" LONG	\$76.00
	1185-50-W	EXTRA WIDE 5/8 x 2" 1150 FILLER 12" LONG	\$61.00
	1185-52-W	EXTRA WIDE 5/8 x 2" 1152 FILLER 24" LONG	\$76.00

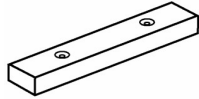

1180 SERIES FILLER PLATE FOR FRAME WITH NARROW STOP

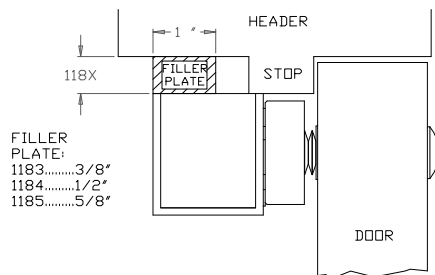

1180-W SERIES WIDE FILLER PLATE FOR FRAME WITH LIP STOP

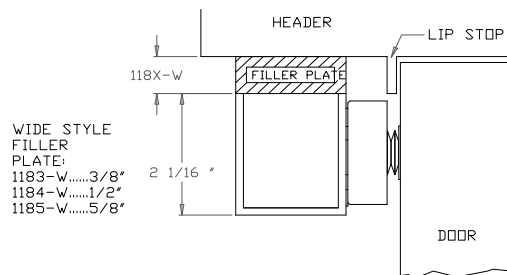

MAGNETIC LOCKS



1180 SERIES

PART # DESCRIPTION LIST PRICE
CUSTOM FINISHES - STANDARD FILLER PLATES

<u>(SUFFIX)</u>	<u>SPECIAL FINISHES ADD TO FILLER PLATES</u>	<u>(ADD)</u>
xDBA	ADD FOR DARK BRONZE ANODIZED -	\$60.00
xUS26	ADD FOR POLISHED CHROME -	
xUS26D	ADD FOR SATIN CHROME -	
xUS3	ADD FOR POLISHED BRASS -	
xUS4	ADD FOR SATIN BRASS -	

1107 FINISHES NOT OFFERED	N/A
1110/1115 (SINGLE LOCK) FILLER PLATES	\$170.00
1150/1155 (SINGLE LOCK) FILLER PLATES	\$180.00
1120 (DOUBLE LOCK) FILLER PLATES	\$240.00
1152 (DOUBLE LOCK) FILLER PLATES	\$250.00



MAGNETIC LOCKS

	<u>PART #</u>	<u>DESCRIPTION</u>	<u>LIST PRICE</u>
1190 SERIES	ANGLE BRACKETS		
	1" x 1" ANGLE BRACKET		
	1191-00	1"X1" 1000 SERIES ANGLE 8-1/4" LONG	\$42.00
	1191-06	1"X1" 1107 SERIES ANGLE 8-1/4" LONG	\$42.00
	1191-10	1"X1" 1110/1115 SERIES ANGLE 12-1/2"LONG	\$55.00
	1191-20	1"X1" 1120 SERIES ANGLE 23" LONG	\$75.00
	1191-50	1"X1" 1150/1155 SERIES ANGLE 12"LONG	\$55.00
	1191-52	1"X1" 1152 SERIES ANGLE 24" LONG	\$75.00
	1-1/2" x 1-1/2" ANGLE BRACKET		
	1192-00	1-1/2"X 2" 1000 SERIES ANGLE 8-1/4"LONG	\$44.00
	1192-06	1-1/2"X1-1/2" 1107 SERIES ANGL 8-1/4"LONG	\$44.00
	1192-10	1-1/2"X1-1/2" 1110/1115 SERIES ANGLE 12-1/2"LONG	\$58.00
	1192-20	1-1/2"X1-1/2" 1120 SERIES ANGLE 23" LONG	\$85.00
	1192-50	1-1/2"X1-1/2" 1150/1155 SERIES ANGLE 12"LONG	\$58.00
	1192-52	1-1/2"X1-1/2" 1152 SERIES ANGLE 24" LONG	\$75.00
	DEPTH X HEIGHT		
	2" x 1-1/2" ANGLE BRACKET		
	1193-00	2"X 2" 1000 SERIES ANGLE 8-1/4" LONG	\$60.00
	1193-06	2"X1-1/2" 1107 SERIES ANGLE 8-1/4" LONG	\$60.00
	1193-10	2"X1-1/2" 1110/1115 SERIES ANGLE 12-1/2"LONG	\$77.00
	1193-20	2"X1-1/2" 1120 SERIES ANGLE 23" LONG	\$95.00
	1193-50	2"X1-1/2" 1150/1155 SERIES ANGLE 12"LONG	\$77.00
	1193-52	2"X1-1/2" 1152 SERIES ANGLE 24" LONG	\$95.00
	DEPTH X HEIGHT		
	2-1/2" x 2" ANGLE BRACKET		
	1194-00	2-3/8"X2" 1000 SERIES ANGLE 8-1/4" LONG	\$65.00
	1194-06	2-1/2"X2" 1107 SERIES ANGLE 8-1/4" LONG	\$65.00
	1194-10	2-1/2"X2" 1110/1115 SERIES ANGLE 12-1/2"LONG	\$80.00
	1194-20	2-1/2"X2" 1120 SERIES ANGLE 23" LONG	\$100.00
	1194-50	2-1/2"X2" 1150/1155 SERIES ANGLE 12"LONG	\$80.00
	1194-52	2-1/2"X2" 1152 SERIES ANGLE 24" LONG	\$100.00

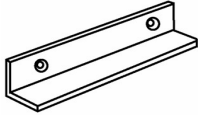

1194 ANGLE BRACKET

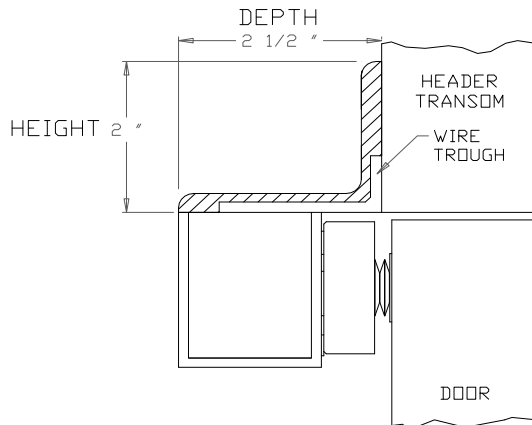



MAGNETIC LOCKS

1190 SERIES	<u>PART #</u>	<u>DESCRIPTION</u>	<u>LIST PRICE</u>
	<u>(SUFFIX)</u>	<u>SPECIAL FINISHES ADD TO ANGLE BRACKETS</u>	<u>(ADD)</u>
	xDBA	ADD FOR DARK BRONZE ANODIZED - ALL STANDARD ANGLE BRACKETS	\$30.00
	xUS26	ADD FOR POLISHED CHROME -	
	xUS26D	ADD FOR SATIN CHROME -	
	xUS3	ADD FOR POLISHED BRASS -	
	xUS4	ADD FOR SATIN BRASS -	
		1107 FINISHES NOT OFFERED	N/A
		1110/1115 (SINGLE LOCK) ANGLE BRACKETS	\$105.00
		1150/1155 (SINGLE LOCK) ANGLE BRACKETS	\$120.00
		1120 (DOUBLE LOCK) ANGLE BRACKETS	\$180.00
		1152 (DOUBLE LOCK) ANGLE BRACKETS	\$190.00



MAGNETIC LOCKS

1190 SERIES

PART # DESCRIPTION LIST PRICE
"Z" BRACKET ACCESSORIES

Z-BRACKET SPACERS & BLOCKS

1176-06S1	1/8" SPACER FOR 1107	\$44.00
1176-00S1	1/8" SPACER FOR 1000	\$46.00
1176-10S1	1/8" SPACER FOR 1110/1150 (1120/1152, 2 REQUIRED)	\$48.00
1176-15S1	1/8" SPACER FOR 1115/1155 (2 REQUIRED)	\$42.00
1176-06S2	1/4" SPACER FOR 1107	\$50.00
1176-00S2	1/4" SPACER FOR 1000	\$54.00
1176-10S2	1/4" SPACER FOR 1110/1150 (1120/1152, 2 REQUIRED)	\$56.00
1176-15S2	1/4" SPACER FOR 1115/1155 (2 REQUIRED)	\$46.00
1176-06B1	1" BLOCK FOR 1107	\$96.00
1176-00B1	1" BLOCK FOR 1000	\$102.00
1176-10B1	1" BLOCK FOR 1110/1150 (1120/1152, 2 REQUIRED)	\$106.00
1176-15B1	1" BLOCK FOR 1115/1155 (2 REQUIRED)	\$92.00

SPECIAL FINISH Z-BRACKETS, SPACERS & BLOCKS

(Call for quote)

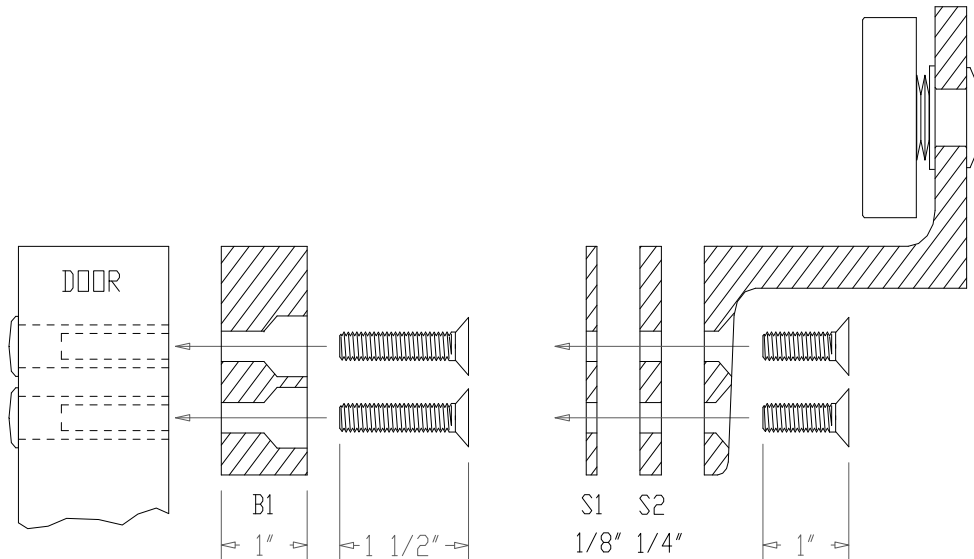



MAGNETIC LOCKS

1190 SERIES	PART #	DESCRIPTION	LIST PRICE
ARMATURE MOUNTING BRACKETS			
		<u>2" x 2" ARMATURE BRACKET w/ SEX NUT</u>	
	1195-06	ARMATURE BRACKET FOR 1107 LOCKS	\$64.00
	1195-10	ARMATURE BRACKET FOR 1110 LOCKS	\$76.00
	1195-15L	ARMATURE BRACKET FOR LEFT ARMATURE 1115	\$62.00
	1195-15R	ARMATURE BRACKET FOR RIGHT ARMATURE 1115	\$62.00
		<u>2-1/2" x 2-1/2" BRACKET w/ SEX NUT</u>	
		<u>FOR 1000 & 1150 SERIES LOCKS</u>	
	1195-50	ARMATURE BRACKET FOR 1150 & 1000 LOCKS	\$84.00
	1195-55L	ARMATURE BRACKET FOR 1155 LEFT ARMATURE	\$70.00
	1195-55R	ARMATURE BRACKET FOR 1155 RIGHT ARMATURE	\$70.00
	<u>2-1/2" x 2-1/2" BRACKET w/ SEX NUT</u>		
1197-06	ARMATURE BRACKET FOR 1107 LOCKS	\$80.00	
1197-10	ARMATURE BRACKET FOR 1110 LOCKS	\$90.00	
	<u>2-1/2" x 3" BRACKET w/ SEX NUT</u>		
	<u>FOR 1000 & 1150 SERIES LOCKS</u>		
1197-50	ARMATURE BRACKET FOR 1150 & 1000 LOCKS	\$104.00	
	SPECIAL FINISH ARMATURE BRACKETS	(Call for quote)	

1190 SERIES	HERCULITE GLASS DOOR BRACKETS		
		<u>1198 SERIES GLASS DOOR U-BRACKETS</u>	
		SATIN STAINLESS STEEL FINISH (SPECIFY GLASS THICKNESS)	
	1198-50-06	1107 SERIES U-BRACKET FOR 1/2" THICK GLASS DOOR	\$160.00
	1198-75-06	1107 SERIES U-BRACKET FOR 3/4" THICK GLASS DOOR	\$170.00
	1198-50-10	1110/1120 U-BRACKET FOR 1/2" THICK GLASS DOOR	\$160.00
	1198-75-10	1110/1120 U-BRACKET FOR 3/4" THICK GLASS DOOR	\$170.00
	1198-50-15	1115 SERIES U-BRACKET FOR 1/2" THICK GLASS	\$130.00
	1198-75-15	1115 SERIES U-BRACKET FOR 3/4" THICK GLASS	\$140.00
	1198-50-50	1150&1000 SERIES U-BRACKET FOR 1/2" GLASS	\$180.00
	1198-75-50	1150&1000 SERIES U-BRACKET FOR 3/4" GLASS	\$190.00
1198-50-55	1155 SERIES U-BRACKET FOR 1/2" THICK GLASS	\$140.00	
1198-75-55	1155 SERIES U-BRACKET FOR 3/4" THICK GLASS	\$150.00	
<u>(SUFFIX)</u>	<u>U-BRACKET SPECIAL FINISHES</u>	<u>(ADD)</u>	
	STANDARD FINISH IS SATIN STAINLESS		
xUS3	ADD FOR POLISHED BRASS	\$210.00	
xUS4	ADD FOR SATIN BRASS	\$210.00	
xUS26	ADD FOR POLISHED CHROME	\$210.00	

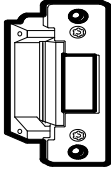
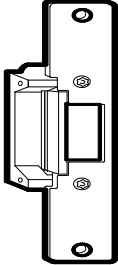

ELECTRIC STRIKES

	<u>PART #</u>	<u>DESCRIPTION</u>	<u>LIST PRICE</u>
3300 SERIES		ELECTRIC STRIKES	
	3300	STANDARD ANSI STRIKES 12/24 DC ANSI STRIKE - FIELD SELECTABLE FAIL-SAFE/FAIL-SECURE FOR METAL DOOR FRAME	\$220.00
	3300xD	12/24 DC ANSI STRIKE WITH LATCH BOLT MONITOR SWITCH (SPDT) - FIELD SELECTABLE FAIL-SAFE/FAIL-SECURE FOR METAL DOOR FRAME	\$300.00
	3311	WOOD FRAME STRIKE PLATE ONLY CONVERTS ANSI STYLE TO 9" TALL STRIKE FOR WOOD DOOR FRAME	\$24.00
	3381 3382	JAMB EXTENSION BRACKETS FOR USE WITH DEEP DOOR JAMB APPLICATIONS 1 INCH JAMB EXTENSION BRACKET 2 INCH JAMB EXTENSION BRACKET	\$20.00 \$20.00

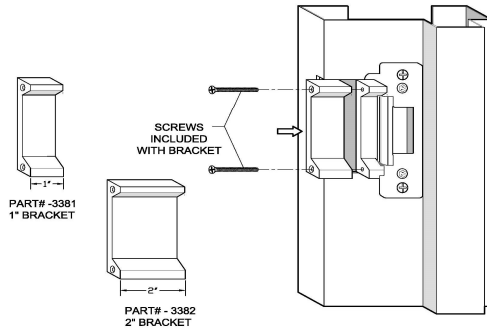



POWER & INTERLOCKING

	<u>PART #</u>	<u>DESCRIPTION</u>	<u>LIST PRICE</u>
4000 SERIES	PLUG-IN POWER SUPPLIES		
		<u>WALL MOUNT PLUG IN POWER SUPPLIES</u>	
	4012	12 VOLT PLUG-IN POWER SUPPLY (1 AMP 12 VDC FOR USE WITH 1100 SERIES MAGLOCKS)	\$75.00
	4024	24 VOLT PLUG-IN POWER SUPPLY (1 AMP 24 VDC FOR USE WITH 1100 SERIES MAGLOCKS)	\$75.00

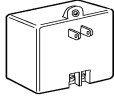

4200 SERIES POWER SUPPLIES

12/24 VDC POWER SUPPLIES

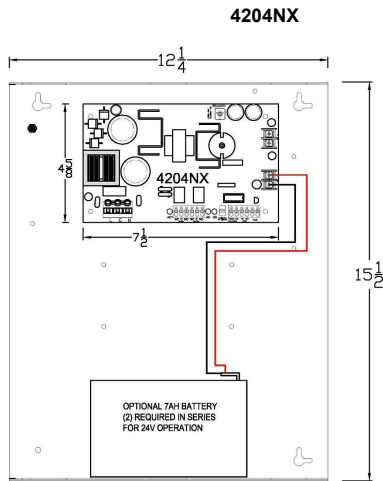

4204NX	4 AMP POWER SUPPLY 12/24 VDC	\$820.00
---------------	-------------------------------------	-----------------

CLASS 2 UL294 RATED ,WITH BATTERY CHARGING CIRCUIT & FIRE ALARM RELAY. THE AUXILLARY CLASS 2 POWER LIMITED OUTPUT SUPPLIES CONTINUOUS DC POWER WHILE A SECOND OUTPUT PROVIDES SWITCHED DC POWER THROUGH THE BUILT IN FIRE ALARM RELAY. FURNISHED IN A 15-1/2" x 12-1/4" x 4-1/2" ELECTRICAL BOX. SEE SERIES 4200 OPTIONS BELOW

4206NX	6 AMP POWER SUPPLY 12/24 VDC	\$1,020.00
---------------	-------------------------------------	-------------------

4210NX-24	10 AMP POWER SUPPLY 24 VDC	\$1,120.00
------------------	-----------------------------------	-------------------

4200 SERIES POWER SUPPLY OPTIONS

4200 SERIES OPTIONS:

ADD FOR LARGER ENCLOSURES AS REQUIRED TO ACCOMMODATE MULTIPLE OPTIONS BELOW

(SUFFIX)

(ADD)

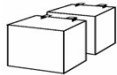

xBAT

12/24 VDC - 14 AMP HOUR BATTERY PACK INCLUDES 2 EACH 7 AH 12 VOLT RECHARGEABLE BATTERIES w/ HOOK-UP CABLES

\$170.00

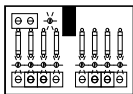

xFO

8-ZONE FUSED OUTPUT BOARD (POWER DISTRIBUTION) 4-1/4" LONG X 3" WIDE

\$140.00



xTERM

10 POSITION DOUBLE ROW TERMINAL 6 1/2" LONG

\$40.00

xCT

COVER TAMPER SWITCH FOR ENCLOSURE

\$60.00



POWER & INTERLOCKING

4300 SERIES	<u>PART #</u>	<u>DESCRIPTION</u>	<u>LIST PRICE</u>
--------------------	---------------	--------------------	-------------------

MANTRAPS & INTERLOCKS

ALL 4300 INTERLOCKS ARE FACTORY CONFIGURED

RELAY LOGIC 2-DOOR INTERLOCK CONTROLLERS ARE OFFERED IN STANDARD CONFIGURATIONS WHICH ALLOW FOR ONE DOOR STATUS AND ONE R-E-X INPUT PLUS ONE DPDT LOCK RELAY OUTPUT PER DOOR. A 4204 CLASS 2 UL-294 POWER SUPPLY INCLUDED IN THE 12-1/4 x 15-1/2 x 4" NEMA ENCLOSURE PROVIDES 4 AMPS OF 12 or 24 VDC POWER FOR MAGLOCKS, STRIKES & LED's. A FIRE ALARM RELAY INPUT IS STANDARD.

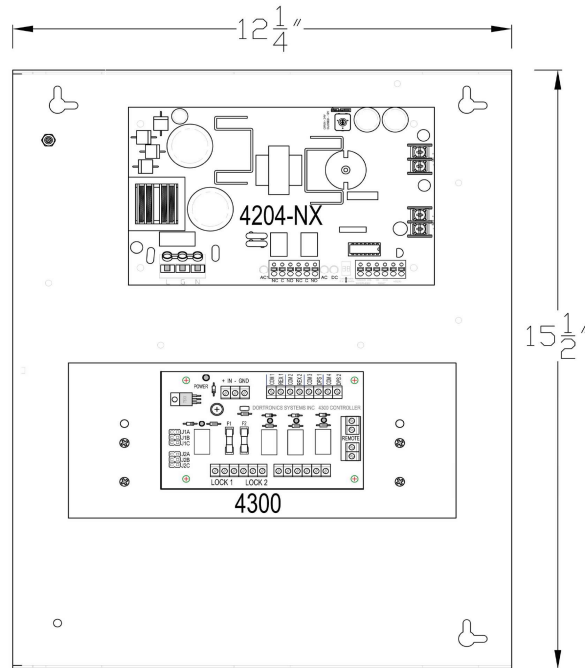

REQUEST MANTRAP / INTERLOCK CHECK LIST FROM FACTORY TO PROPERLY CONFIGURE 4300 CONTROLLERS

STANDARD CONFIGURATIONS

4300 SERIES 2 DOOR MANTRAP INTERLOCKS		
43211-U	2-Doors – 1-Room - All Doors Normally Unlocked	\$1,346.00
43211-LU	2-Doors – 1-Room - 1-Door Locked & 1-Door Unlocked	
43211-L	2-Doors – 1-Room - All Doors Normally Locked	
4300020	Controller board only	\$530.00
COMMUNICATING BATH CONTROLLER		
43211-CB	2-Doors – 1-Room - Doors Normally Unlocked	\$1,412.00
(SUFFIX)		(ADD)
xBAT	12/24 VDC - 14 AMP HOUR BATTERY PACK INCLUDES 2 EACH 7 AH 12 VOLT RECHARGEABLE BATTERIES w/ HOOK-UP CABLES	\$170.00
xCT	COVER TAMPER SWITCH FOR ENCLOSURE	\$60.00

SEE 4800 & 4900 SERIES ON FOLLOWING PAGES FOR MORE COMPLEX MANTRAP CONFIGURATIONS



POWER & INTERLOCKING

PART #

DESCRIPTION

LIST PRICE

48500 SERIES 2 - 5 DOOR USER CONFIGURED INTERLOCKS

THE 48500 SERIES INTERLOCK CONTROLLER ALLOWS THE USER TO INTERLOCK FROM TWO TO FIVE DOORS IN ANY COMBINATION AND CONFIGURE THE DOORS FOR LOCKED OR UNLOCKED, FAIL SAFE OR FAIL SECURE OPERATION IN THE FIELD. THE THE INSTALLER HAS COMPLETE CONTROL OVER THE INTERLOCK FUNCTIONS. EACH DOOR HAS A RELAY WITH PROTECTION BY FUSE AND WET OR DRY CONTACT SELECTOR, A TRAFFIC LIGHT OUTPUT POWERED FOR DIRECT CONNECTION TO INDICATORS, A DEDICATED DOOR STATUS RELAY, A DOOR POSITION INPUT AND A R-E-X INPUT FOR NORMALLY LOCKED DOORS.

THE SYSTEM HAS AN EMERGENCY UNLOCK FOR ALL DOORS WITH AN ALARM, AN INTERLOCK VIOLATION ALARM, THREE TIMERS FOR PROPPED DOOR TIME, PANIC UNLOCK TIME & REX UNLOCK DELAY.

THE INTERLOCK FUNCTION HAS A SHUNT INPUT THAT DEFEATS THE INTERLOCK FOR DAY/NIGHT MODE, BUT LEAVES THE ACCESS CONTROL SETTINGS UNAFFECTED.

THE 48500 CONTROLLER MAY BE ORDERED BOARD ONLY, OR AS A COMPLETE SYSTEM WITH A 4204NX CLASS 2 UL294 POWER SUPPLY (120 VAC IN - 12 OR 24 VDC OUT @ 4 AMPS) WITH FIRE ALARM INTERFACE, IN A LOCKABLE NEMA ENCLOSURE. THE NUMBER OF LOCKS AND TOTAL CURRENT DRAW MAY REQUIRE ADDITIONAL POWER. 6 & 10 AMP SUPPLIES ARE ALSO AVAILABLE.

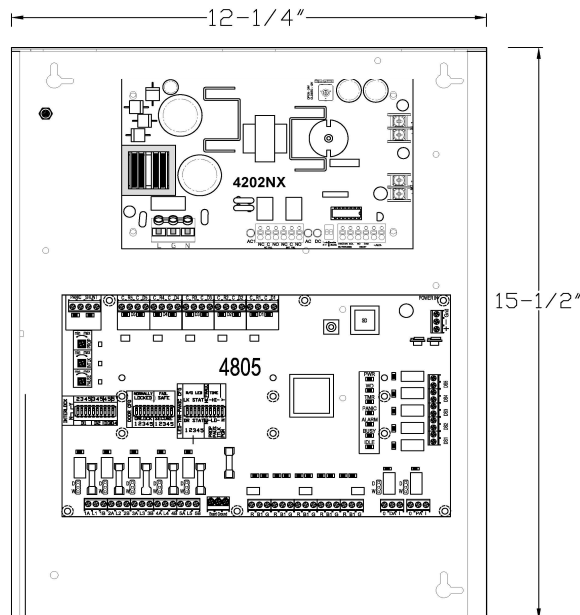

4800 SERIES 2-5 DOOR MANTRAP INTERLOCKS & OPTIONS

48501	MOUNTED IN NEMA ENCLOSURE WITH 4AMP SUPPLY UP TO 5 DOORS FIELD CONFIGURED	\$2,360.00
48500	PLC BOARD ONLY (no enclosure) UP TO 5 DOORS	\$1,550.00
(SUFFIX)		(ADD)
xAUX	AUXILIARY 5 RELAY OUTPUT HARNESS FOR AUTOMATIC DOOR OPERATORS	\$125.00
xADO	AUTOMATIC DOORS WITH LOCKED CONFIGURATION	\$100.00
xBAT	12/24 VDC - 14 AMP HOUR BATTERY PACK	\$170.00
xCT	COVER TAMPER SWITCH FOR ENCLOSURE DOOR	\$60.00
- 6	W/6 AMP OUTPUT POWER SUPPLY	\$365.00
-10	W/10 AMP OUTPUT POWER SUPPLY (specify 12 or 24V)	\$465.00
-220	220 VAC INPUT	\$100.00
-NP	48500 CONTROLLER BOARD MOUNTED IN ENCLOSURE NO POWER SUPPLY	\$1,870.00
SEE 48900 SERIES ON NEXT PAGE FOR MORE INTERLOCK CONFIGURATIONS		



POWER & INTERLOCKING

PART #

DESCRIPTION

LIST PRICE

48900 SERIES 2 - 9 DOOR USER CONFIGURED INTERLOCKS

THE 48900 SERIES MANTRAP CONTROLLER ALLOWS THE USER TO INTERLOCK FROM TWO TO NINE DOORS IN ANY COMBINATION AND CONFIGURE THE DOORS FOR LOCKED OR UNLOCKED, FAIL SAFE OR FAIL SECURE OPERATION IN THE FIELD. THE PLC BASED LOGIC GIVES THE INSTALLER COMPLETE CONTROL OVER THE INTERLOCK FUNCTIONS. EACH DOOR IN THE MANTRAP HAS AN INDEPENDENT CONTROL RELAY PROTECTED BY FUSE AND WET OR DRY CONTACT SELECTOR, A DEDICATED TRAFFIC LIGHT OUTPUT THAT IS POWERED FOR CONNECTION TO INDICATORS, A DOOR STATUS RELAY, A DOOR POSITION INPUT AND A R-E-X INPUT FOR NORMALLY LOCKED DOORS. THE SYSTEM FEATURES AN EMERGENCY UNLOCK FOR ALL DOORS WITH AN ALARM, AN INTERLOCK VIOLATION ALARM, THREE ONBOARD ADJUSTABLE TIMERS FOR PROPPED DOOR TIME, PANIC RELEASE UNLOCK TIME & UNLOCK TIMER FOR REX UNLOCK DELAY. THE INTERLOCK FUNCTION HAS A SHUNT INPUT THAT DEFEATS THE INTERLOCK FOR DAY/NIGHT MODE, BUT LEAVES THE ACCESS CONTROL SETTINGS UNAFFECTED.

THE 48900 CONTROLLER MAY BE ORDERED BOARD ONLY, MOUNTED ON A BACK PLATE OR AS A COMPLETE SYSTEM WITH A 4204NX CLASS 2 UL294 4 Amp POWER SUPPLY WITH FIRE ALARM INTERFACE, MOUNTED IN A LOCKABLE NEMA ENCLOSURE. THE NUMBER OF LOCKS AND TOTAL CURRENT DRAW MAY REQUIRE ADDITIONAL POWER. 6 & 10 AMP SUPPLIES ARE ALSO AVAILABLE.

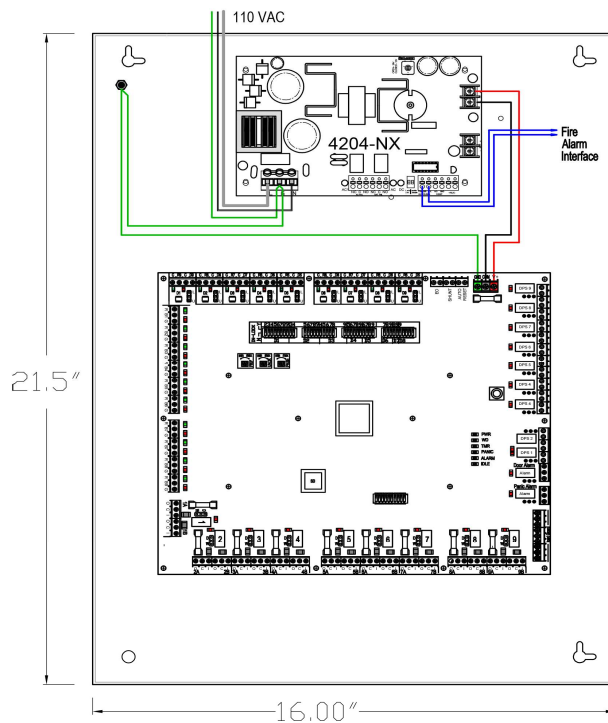

48900 SERIES 2-9 DOOR INTERLOCKS & OPTIONS

48901	MOUNTED IN NEMA ENCLOSURE WITH 4AMP SUPPLY UP TO 9 DOORS FIELD CONFIGURED	\$4,585.00
48900xPA	PANEL MOUNTED 48900 CONTROLLER 11.5" X 13.5"	\$3,560.00
48900	PLC BOARD ONLY (NO PANEL OR ENCLOSURE)	\$3,480.00
xADO	AUTOMATIC DOORS WITH LOCKED CONFIGURATION	\$200.00
xBAT	12/24 VDC - 14 AMP HOUR BATTERY PACK	\$170.00
xCT	COVER TAMPER SWITCH FOR ENCLOSURE	\$60.00
- 6	W/6 AMP OUTPUT POWER SUPPLY	\$365.00
-10	W/10 AMP OUTPUT POWER SUPPLY (specify 12 or 24V)	\$465.00
-220	220 VAC INPUT	\$100.00
-NP	48500 CONTROLLER BOARD MOUNTED IN ENCLOSURE NO POWER SUPPLY	\$4,100.00

SEE 4900 SERIES ON NEXT PAGE FOR MORE INTERLOCK CONFIGURATIONS



POWER & INTERLOCKING

PART #	DESCRIPTION	LIST PRICE
4900 SERIES	PLC INTERLOCKS	

ALL 4900 INTERLOCKS ARE FACTORY PROGRAMMED

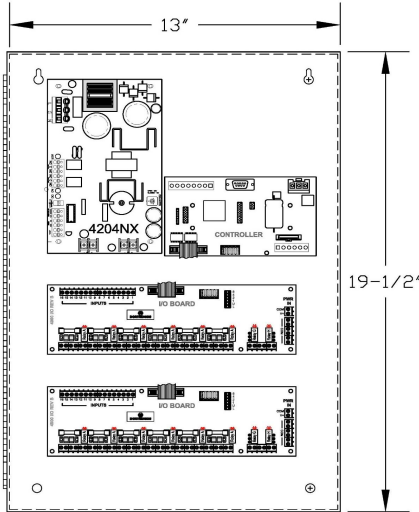

PLC BASED MULTI ROOM / MULTI DOOR, INTERLOCK & MANTRAP CONTROLLERS ARE OFFERED IN STANDARD CONFIGURATIONS WHICH ALLOW FOR ONE DOOR STATUS AND ONE R-E-X INPUT PLUS ONE DPDT LOCK RELAY OUTPUT PER DOOR. ADDITIONAL INPUT AND OUTPUT CAPABILITY PLUS CUSTOM OPERATIONAL CHARACTERISTICS INCLUDING SEQUENCING AND TIMING MAY BE DESIGNED INTO THE UNIT UPON REQUEST.
UP TO 120 TOTAL DOORS MAY BE CONFIGURED

A 4204 CLASS 2 UL-294 POWER SUPPLY INCLUDED IN THE 12-1/4 x 15-1/2 x 4" NEMA ENCLOSURE PROVIDES 4 AMPS OF 12 or 24 VDC POWER FOR MAGLOCKS, STRIKES & LED'S. A FIRE ALARM RELAY INPUT IS STANDARD. THE NUMBER OF LOCKS AND TOTAL CURRENT DRAW MAY REQUIRE ADDITIONAL POWER .

REQUEST MANTRAP / INTERLOCK CHECK LIST FROM FACTORY TO PROPERLY CONFIGURE 4900 PLC CONTROLLERS

STANDARD CONFIGURATIONS

49211-U	2-Doors – 1-Room - All Doors Normally Unlocked	\$3,240.00
49211-L	2-Doors – 1-Room - All Doors Normally Locked	
4900 SERIES 3 DOOR INTERLOCKS		
49311-U	3-Doors – 1-Room - All Doors Normally Unlocked	\$3,450.00
49311-L	3-Doors – 1-Room - All Doors Normally Locked	
49311-LU	3-Doors – 1-Room - Doors Locked & Unlocked	
4900 SERIES 4 DOOR INTERLOCKS		
49411D-U	4-Doors – 1-Room - All Doors Normally Unlocked	\$4,270.00
49411D-L	4-Doors – 1-Room - All Doors Normally Locked	
49411D-LU	4-Doors – 1-Room - Doors Locked & Unlocked	
(SUFFIX)	OPTIONS	(ADD)
xBAT	12/24 VDC - 14 AMP HOUR BATTERY PACK INCLUDES 2 EACH 7 AH 12 VOLT RECHARGEABLE BATTERIES w/ HOOK-UP CABLES (NOTE) THIS OPTION CAN ONLY BE USED WITH SINGLE I/O BOARD CONFIGURATIONS. CONTACT FACTORY FOR LARGER ENCLOSURE SIZES	\$170.00
xCT	COVER TAMPER SWITCH FOR ENCLOSURE	\$60.00
XDSP	PROGRAMMABLE I/O WITH NUMERIC DISPLAY USER SELECTABLE MULTIFUNCTION PROGRAM TIMER ALLOWS CUSTOM CONFIGURATION OF INPUT/OUTPUT & TIMING FUNCTIONS	\$680.00
- 6	W/6 AMP OUTPUT POWER SUPPLY	\$365.00
-10	W/10 AMP OUTPUT POWER SUPPLY (specify 12 or 24V)	\$465.00
49000-PRGM	CUSTOM CONFIGURATION PROGRAMMING FACTORY PROGRAMMING TO CUSTOM APPLICATION SPECIFICATIONS QUOTED ON AN HOURLY BASIS	\$400.00

*****MANY OTHER CONFIGURATIONS AVAILABLE CONTACT FACTORY*****
OVER 4 DOORS & UP TO 120 DOORS CONTACT THE FACTORY FOR A QUOTE AS THESE
WILL BE CUSTOM CONFIGURED TO YOUR SPECIFICATIONS
 ("DOORS" REFERS TO EACH OPENING WHICH MAY BE A PAIR OF DOORS)

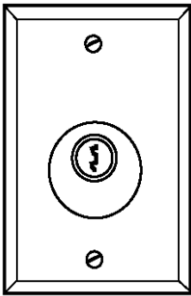
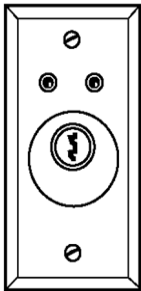

ACTUATORS

	<u>PART #</u>	<u>DESCRIPTION</u>	<u>LIST PRICE</u>
5100 SERIES KEY SWITCH CONTROLS			
<u>5141 SERIES KEY SWITCHES (W/O CYLINDER)</u>			
 <p>5141-25</p>	5141-23	FORM Z-DELAY ACTION KEY SWITCH ON SINGLE GANG PLATE (PNEUMATIC TIME DELAY)	\$310.00
	5141-24	DPDT ALTERNATE ACTION KEY SWITCH ON SINGLE GANG PLATE	\$150.00
	5141-25	DPDT MOMENTARY ACTION KEY SWITCH ON SINGLE GANG PLATE	\$146.00
	5141-2/24	TWO POSITION KEY SWITCH ON SINGLE GANG PLATE w/ 2-DPDT MAINTAINED ACTION CONTACT SWITCHES	\$210.00
	5141-2-25	TWO POSITION KEY SWITCH ON SINGLE GANG PLATE w/ 2-DPDT MOMENTARY ACTION CONTACT SWITCHES	\$190.00
	5141-24-25	TWO POSITION KEY SWITCH ON SINGLE GANG PLATE w/ 2-DPDT SWITCHES 1 MOMENTARY, 1 MAINTAINED	\$200.00
(MOUNTING KIT INCLUDES CYLINDER NUT, PIN HEX SCREWS AND PIN HEX ALLEN WRENCH)			
 <p>N5141-25XL2XK</p>	(SUFFIX)	<u>5141 KEY SWITCH OPTIONS (ADD TO ABOVE):</u>	(ADD)
	xK	STANDARD 1-1/8" MORTISE CYLINDER & 2 KEYS	\$70.00
	xKNR	CYLINDER WITH KEY NON-REMOVABLE IN "ON" POSITION (single switch Mom. configuration only)	\$95.00
	xP15	ADD SPDT PUSH BUTTON SWITCH	\$34.00
	xCS	ADD DC PIEZO SOUNDER (REQUIRES 2-GANG PLATE)	\$30.00
	xL	ADD 1 LED (BICOLOR RED / GREEN)	\$22.00
	xCT	ADD 1 SPDT COVER TAMPER SWITCH	\$70.00
(SUFFIX)	<u>5141 KEY SWITCH FINISHES</u>	(ADD)	
xUS26	POLISHED CHROME	\$60.00	
xUS3	POLISHED BRASS FINISH	\$60.00	
xUS4	SATIN BRASS FINISH	\$60.00	
(PREFIX)			
N	WITH NARROW 1-3/4" SWITCH PLATE	\$12.00	
D	WITH DOUBLE GANG SWITCH PLATE	\$24.00	
WR	WITH WEATHER RESISTANT SWITCH PLATE (1-GANG)	\$10.00	
5141000	SPARE KEY	\$14.00	
SEE #5240 SERIES & #7286 DOOR PROP ALARMS FOR OTHER KEY SWITCH CONFIGURATIONS			

ACTUATORS



5210 SERIES

PART #	DESCRIPTION	LIST PRICE
MUSHROOM PUSH BUTTONS		
<u>5211 PUSH BUTTONS 1-9/16" DIA</u>		
5211-MP23-*	1-9/16" DIA. MUSHROOM PUSH BUTTON (SPECIFY CAP COLOR) w/ DPST MOMENTARY (1-NO & 1-NC CONTACT) MOUNTED ON SINGLE GANG PLATE	\$122.00
5211-MP24-*	1-9/16" DIA. PALM BUTTON (SPECIFY CAP COLOR) w/ DPST ALT ACTION (1-NO & 1-NC CONTACT) MOUNTED ON SINGLE GANG PLATE	\$170.00
5211-MP23PP	1-9/16" DIA. MUSHROOM PUSH-PULL BUTTON (RED CAP) w/ DPST ALT ACTION (1-NO & 1-NC CONTACT) MOUNTED ON SINGLE GANG PLATE	\$180.00
5211-LMP23	1-9/16" DIA. ILLUMINATED PUSH BUTTON (RED CAP) w/ DPST MOMENTARY ACTION (1-NO & 1-NC CONTACT) MOUNTED ON SINGLE GANG PLATE	\$190.00
5211-MP23DA-*	1-9/16" DIA. MUSHROOM PUSH BUTTON (SPECIFY CAP COLOR) w/PNEUMATIC 2-60 DELAY (FORM Z)	\$350.00
<u>5216 PALM BUTTONS 2-3/8" DIA</u>		
5216-MP23-*	2-3/8" DIA. PALM BUTTON (SPECIFY CAP COLOR) w/ DPST MOMENTARY (1-NO & 1-NC CONTACT)	\$136.00
5216-MP24-*	2-3/8" DIA. PALM BUTTON (SPECIFY CAP COLOR) w/ DPST ALT ACTION (1-NO & 1-NC CONTACT) MOUNTED ON SINGLE GANG PLATE	\$200.00
5216-MP23PP	2-3/8" DIA. PALM BUTTON (RED CAP) PUSH-PULL W/ DPST ALT ACTION (1-NO & 1-NC CONTACT)	\$200.00
5216-MP23DA-*	2-3/8" DIA. PALM BUTTON (SPECIFY CAP COLOR) W/ PNEUMATIC 2-60 SEC. DELAY (FORM Z)	\$360.00
<u>5211/16 LATCHING BUTTONS WITH KEY RESET</u>		
5211-MP23-KR	1-9/16" DIA. DURESS PUSH BUTTON (RED CAP) DPST LATCHING/ KEY RESET (1-NO & 1-NC CONTACT) ON SINGLE GANG PLATE	\$260.00
5216-MP23-KR	2-3/8" DIA. DURESS PUSH BUTTON (RED CAP) DPST LATCHING WITH KEY RESET (1-NO & 1-NC CONTACT) ON SINGLE GANG PLATE	\$300.00
5211-028L	28 VOLT LAMPS- PKG. OF 4	\$16.00
<u>5211 & 5216 PUSH BUTTON OPTIONS:</u>		
(SUFFIX)		(ADD)
-R	* DESIGNATES RED CAP	'N/C
-B	* DESIGNATES BLACK CAP	'N/C
-G	* DESIGNATES GREEN CAP (NON STOCK ITEM)	\$97.00
/BU	* DESIGNATES BLUE CAP (NON STOCK ITEM)	\$97.00
-02CB	ADDITIONAL NO CONTACT BLOCK (Requires 2-3/4"	\$20.00
-03CB	ADDITIONAL NC CONTACT BLOCK deep back box)	\$20.00
xL	ADD 1 LED BLACK BEZEL (BI-COLOR RED/GREEN)	\$22.00
xAT	ADJUSTABLE 1-60 SEC. TIMER DPDT OUTPUT	\$135.00
xFT	FIXED 30 SECOND TIMER DPDT RELAY OUTPUT	\$135.00
XTS	TAMPER PROOF SCREWS & HEX KEY	\$16.00
(SUFFIX)	TEXT OPTIONS (RED TEXT)	(ADD)
xE1	S/S PLATE "PUSH TO EXIT"	\$24.00
xE2	S/S PLATE "PANIC"	\$24.00
xE3	S/S PLATE "EMERGENCY RELEASE"	\$26.00
xE4	S/S PLATE "PUSH TO RELEASE"	\$26.00
xE5	S/S PLATE "PULL TO RELEASE"	\$26.00
xE6	PER PLATE FEE AFTER SET UP	\$30.00
(ORDER AS LINE ITEM)----	CUSTOM TEXT 1 SET UP FEE PER RUN	\$80.00
XHCP	HANDICAP LOGO BLUE TEXT	\$44.00
(PREFIX)	5210 SERIES SWITCH PLATE OPTIONS	(ADD)
WR	WEATHER RESISTANT 1-GANG PLATE	\$10.00
D	DOUBLE GANG SWITCH PLATE	\$24.00
N	NARROW 1-3/4" PLATE FOR FRAME MOUNTING	\$12.00
5210/COV	ANTI TAMPER PLEXIGLAS BUTTON COVER	\$84.00

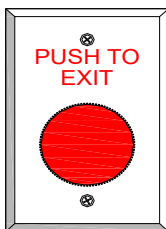

5211-MP23XE1



5216-MP23XE3

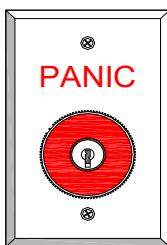

5211-MP23KRXE2

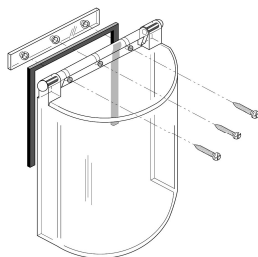

5210/COV

(ORDER AS LINE ITEM)----



ACTUATORS

5215 SERIES

PART # DESCRIPTION

SQUARE EXIT PUSH BUTTONS

LIST PRICE

5215 ILLUMINATED SQUARE PUSH BUTTONS

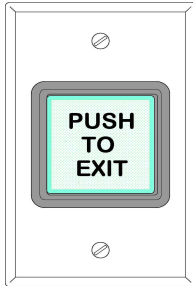

5215-SPBxE1

5215-SPB 1-1/2" ILLUMINATED SQUARE PUSH BUTTON (GREEN COLOR CAP ONLY) w/ SPDT MOMENTARY SWITCH CONTACTS MOUNTED ON SS SINGLE GANG PLATE LAMP BULBS ARE RATED @ 28VDC MAX **\$94.00**

5215-SPBxE1 1-1/2" ILLUMINATED SQUARE PUSH BUTTON "PUSH TO EXIT" LETTERING ON GREEN CAP w/ SPDT MOMENTARY SWITCH CONTACTS MOUNTED ON SS SINGLE GANG PLATE **\$104.00**

5215-SPBxE3 1-1/2" ILLUMINATED SQUARE PUSH BUTTON "EXIT" LETTERING ON GREEN CAP w/ SPDT MOMENTARY SWITCH CONTACTS MOUNTED ON SS SINGLE GANG PLATE **\$104.00**

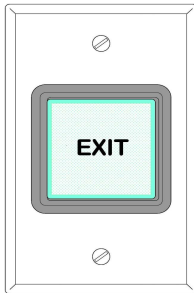

5215-SPBxE3

5215-SPBxL 1-1/2" ILLUMINATED SQUARE PUSH BUTTON (GREEN CAP ONLY) w/ SPDT MOMENTARY SWITCH CONTACTS & BICOLOR LED MOUNTED ON SS SINGLE GANG PLATE **\$114.00**

5215-SPBxLxE1 1-1/2" ILLUMINATED SQUARE PUSH BUTTON "PUSH TO EXIT" LETTERING ON GREEN CAP w/ SPDT MOMENTARY SWITCH CONTACTS & BICOLOR LED MOUNTED ON SS SINGLE GANG PLATE **\$124.00**

5215-SPBxLxE3 1-1/2" ILLUMINATED SQUARE PUSH BUTTON "EXIT" LETTERING ON GREEN CAP w/ SPDT MOMENTARY SWITCH CONTACTS & BICOLOR LED MOUNTED ON SS SINGLE GANG PLATE **\$124.00**

5215-028L 28 VOLT DC MAX REPLACEMENT LAMP **\$8.00**

(SUFFIX)		(ADD)
xAT	1-60 SECOND TIMER DPDT RELAY OUTPUT	\$135.00
xFT	FIXED 30 SECOND TIMER DPDT RELAY OUTPUT	\$135.00

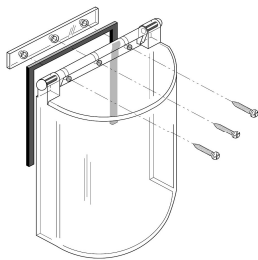

5210/COV

5210-COV **ANTI TAMPER PLEXIGLAS BUTTON COVER** PROTECTS PUSH BUTTON FROM BEING ACCIDENTALLY ACTUATED MOUNTS OVER SINGLE GANG SWITCH. 6-1/2"HIGH x 4"WIDE OVERALL **\$84.00**

ACTUATORS



5220 SERIES

PART # DESCRIPTION LIST PRICE

DELAYED ACTION PUSH BUTTONS

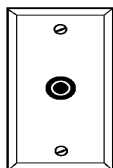

5221-P23DA

(ORDER AS LINE ITEM)----

5221-P23DA	PNEUMATIC TIME DELAY PUSH BUTTON SWITCH	\$290.00
<u>(SUFFIX)</u>	<u>5221 TIME DELAY PUSH BUTTON OPTIONS</u>	<u>(ADD)</u>
xUS3	POLISHED BRASS PLATE	\$60.00
xUS4	SATIN BRASS PLATE	\$60.00
xL	ADD 1 LED BLACK BEZEL (BICOLOR RED / GREEN)	\$22.00
	<u>TEXT OPTIONS</u>	
xE1	S/S PLATE TEXT "PUSH TO EXIT"	\$24.00
xE2	S/S PLATE TEXT "PANIC"	\$24.00
xE3	S/S PLATE TEXT "EMERGENCY RELEASE"	\$26.00
xE4	S/S PLATE TEXT "PUSH TO RELEASE"	\$26.00
xE6	PER PLATE FEE AFTER SET UP	\$30.00
XE6SETUP	CUSTOM TEXT 1 SET UP FEE PER RUN	\$80.00
<u>(PREFIX)</u>	<u>5221 NARROW SWITCH PLATE OPTIONS</u>	
N	ADD NARROW 1-3/4" PLATE FOR FRAME MOUNTING	\$12.00

5230 SERIES

SNAP ACTION PUSH BUTTONS

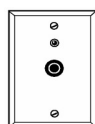

5231-P15

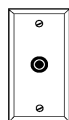

N5231-P15

5231-P15	1 SPDT MOMENTARY PUSH BUTTON (1-GANG PLATE)	\$75.00
5231-2P15	2 SPDT MOMENTARY PUSH BUTTON (1-GANG PLATE)	\$100.00
5231-3P15	3 SPDT MOMENTARY PUSH BUTTON (1-GANG PLATE)	\$120.00
	<u>ENGRAVING OPTIONS SAME AS 5221 ABOVE</u>	
<u>(SUFFIX)</u>	<u>5231 SWITCH OPTIONS (ADD):</u>	<u>(ADD)</u>
xL	ADD 1 LED BLACK BEZEL (BICOLOR RED / GREEN)	\$22.00
<u>(PREFIX)</u>	<u>5231 NARROW SWITCH PLATE OPTIONS</u>	
N	ADD NARROW 1-3/4" PLATE FOR FRAME MOUNTING	\$12.00
D	ADD DOUBLE GANG SWITCH PLATE	\$24.00

5236 SERIES

SNAP ACTION MINI BOX

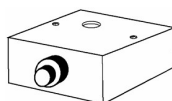

5236-P15

	<u>5236 PUSH BUTTONS ON MINI-BOX CONSOLE</u>	
	<u>2-1/2 LONG X 2 WIDE X 1" HIGH</u>	
5236-P14	1 SPDT MAINTAINED BUTTON MINI-BOX MOUNTED	\$110.00
5236-2P14	2 SPDT MAINTAINED BUTTONS MINI-BOX MOUNTED	\$136.00
5236-3P14	3 SPDT MAINTAINED BUTTONS MINI-BOX MOUNTED	\$166.00
5236-P15	1 SPDT MOMENTARY BUTTON MINI-BOX MOUNTED	\$110.00
5236-2P15	2 SPDT MOMENTARY BUTTONS MINI-BOX MOUNTED	\$136.00
5236-3P15	3 SPDT MOMENTARY BUTTONS MINI-BOX MOUNTED	\$166.00
5236-P24	1 DPDT MAINTAINED BUTTON MINI-BOX MOUNTED	\$142.00
5236-2P24	2 DPDT MAINTAINED BUTTONS MINI-BOX MOUNTED	\$202.00
5236-3P24	3 DPDT MAINTAINED BUTTONS MINI-BOX MOUNTED	\$262.00
5236-P25	1 DPDT MOMENTARY BUTTON MINI-BOX MOUNTED	\$136.00
5236-2P25	2 DPDT MOMENTARY BUTTONS MINI-BOX MOUNTED	\$190.00
5236-3P25	3 DPDT MOMENTARY BUTTONS MINI-BOX MOUNTED	\$244.00
5236-T24	1 DPDT MAINTAINED TOGGLE MINI-BOX MOUNTED	\$142.00
	<u>HEAVY DUTY ALL METAL BUTTONS</u>	
5236-P24-H	1 DPDT MAINTAINED BUTTON MINI-BOX MOUNTED	\$178.00
5236-2P24-H	2 DPDT MAINTAINED BUTTONS MINI-BOX MOUNTED	\$230.00
5236-3P24-H	3 DPDT MAINTAINED BUTTONS MINI-BOX MOUNTED	\$288.00
5236-P25-H	1 DPDT MOMENTARY BUTTON MINI-BOX MOUNTED	\$178.00
5236-2P25-H	2 DPDT MOMENTARY BUTTONS MINI-BOX MOUNTED	\$230.00
5236-3P25-H	3 DPDT MOMENTARY BUTTONS MINI-BOX MOUNTED	\$288.00
<u>(SUFFIX)</u>	<u>SWITCH OPTIONS (ADD TO ABOVE):</u>	<u>(ADD)</u>
xL	ADD 1 LED (BICOLOR RED / GREEN) 2P-15 ONLY	\$22.00
xL2	ADD 2 LEDS (BICOLOR RED / GREEN) P-15 ONLY	\$34.00

ACTUATORS



5240 SERIES

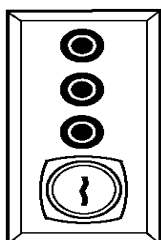

5241-K24x3P15

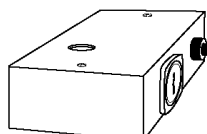

5246-K24xP15

PART #	DESCRIPTION	LIST PRICE
ELECTRICAL KEY SWITCH CONTROLS		
<u>5241 KEY SWITCHES ON SINGLE GANG PLATE</u>		
5241-K12	SP N.O. MOM KEY REMOVABLE ONE POSITION	\$115.00
5241-K24	SPDT-MAINTAIN KEY REMOVABLE TWO POSITIONS	\$100.00
5241-K331	DPDT MAINT. KEY REMOVABLE IN ONE POSITION	\$118.00
5241-K332	DPDT MAINT. KEY REMOVABLE IN TWO POSITIONS	\$118.00
5246000K	SPARE KEY SPECIFY K24 THRU K332	\$14.00
D (Prefix)	DOUBLE GANG SWITCH PLATE	\$24.00
<u>5246 KEY SWITCH ON UNDER DESK CONSOLE</u>		
3-3/4" LONG X 2-1/2" WIDE X 1-1/2" HIGH		
5246-K24	SPDT KEY SWITCH KEY REMOVABLE IN TWO POSITIONS ADD PUSH BUTTONS BELOW AS REQUIRED (3/8" DIA)	\$160.00
5246-2K24	DUAL SPDT KEY SWITCHES KEY REMOVABLE IN TWO POSITIONS ADD MAX 2 PUSH BUTTONS BELOW AS REQUIRED (3/8" DIA)	\$220.00
5246-K331	DPDT KEY SWITCH KEY REMOVABLE IN ONE POSITION ADD PUSH BUTTONS BELOW AS REQUIRED (3/8" DIA)	\$226.00
5246-K332	DPDT KEY SWITCH KEY REMOVABLE IN TWO POSITIONS ADD PUSH BUTTONS BELOW AS REQUIRED (3/8" DIA)	\$226.00
5246	ENCLOSURE W/O KEY SWITCH FOR ADDING OPTIONAL COMPONENTS BELOW	\$90.00
<u>(SUFFIX)</u>	<u>5246 SWITCH OPTIONS (ADD TO ABOVE)</u>	<u>(ADD)</u>
	ANY COMBINATION OF 4 LED's OR PUSH BUTTONS MAY BE COMBINED w/ 1 KEY SWITCH	
	LEDS	
xL	ADD 1 LED BLACK BEZEL (BICOLOR RED / GREEN)	\$22.00
	SPDT MAINTAINED BUTTONS	
xP14	ADD ONE SPDT MAINTAINED BUTTON	\$36.00
x2P14	ADD TWO SPDT MAINTAINED BUTTONS	\$72.00
x3P14	ADD THREE SPDT MAINTAINED BUTTONS	\$108.00
x4P14	ADD FOUR SPDT MAINTAINED BUTTONS	\$144.00
	SPDT MOMENTARY BUTTONS	
xP15	ADD ONE SPDT MOM PUSH BUTTON	\$36.00
x2P15	ADD TWO SPDT MOM PUSH BUTTONS	\$72.00
x3P15	ADD THREE SPDT MOM PUSH BUTTONS	\$108.00
x4P15	ADD FOUR SPDT MOM PUSH BUTTONS	\$144.00
	DPDT MOMENTARY BUTTONS	
xP25	ADD ONE DPDT MOMENTARY BUTTON	\$65.00
x2P25	ADD TWO DPDT MOMENTARY BUTTONS	\$130.00
x3P25	ADD THREE DPDT MOMENTARY BUTTONS	\$195.00
x4P25	ADD FOUR DPDT MOMENTARY BUTTONS	\$260.00
	DPDT MAINTAINED BUTTONS	
xP24	ADD ONE DPDT MAINTAINED BUTTON	\$70.00
x2P24	ADD TWO DPDT MAINTAINED BUTTONS	\$140.00
x3P24	ADD THREE DPDT MAINTAINED BUTTONS	\$210.00
x4P24	ADD FOUR DPDT MAINTAINED BUTTONS	\$280.00
	<u>HEAVY DUTY ALL METAL BUTTONS</u>	
xP24-H	ADD 1 DPDT MAINTAINED HEAVY DUTY BUTTON	\$100.00
x2P24-H	ADD 2 DPDT MAINTAINED HEAVY DUTY BUTTONS	\$200.00
xP25-H	ADD 1 DPDT MOMENTARY HEAVY DUTY BUTTON	\$100.00
x2P25-H	ADD 2 DPDT MOMENTARY HEAVY DUTY BUTTONS	\$200.00
xT24	ADD 1 DPDT MAINTAINED TOGGLE	\$68.00

ACTUATORS



5260 SERIES

PART #	DESCRIPTION	LIST PRICE
RECTANGULAR PUSH BUTTONS		
<u>5260 SERIES RECTANGULAR PUSH BUTTONS</u>		
5260-24-*	5/8" x 7/8" RECTANGULAR PLASTIC BUTTON MAINTAINED DPDT FORM-C CONTACTS ON 1- GANG SS PLATE	\$96.00
5260-25-*	5/8" x 7/8" RECTANGULAR PLASTIC BUTTON MOMENTARY DPDT FORM-C CONTACTS ON 1-GANG SS PLATE	\$96.00
5260-LMP24-*	ILLUMINATED 5/8" x 7/8" RECTANGULAR PLASTIC BUTTON MAINTAINED DPDT 1- GANG SS PLATE	\$146.00
5260-LMP25-*	ILLUMINATED 5/8" x 7/8" RECTANGULAR PLASTIC BUTTON MOMENTARY DPDT 1- GANG SS PLATE	\$146.00
5260-24-25*	TWO RECTANGULAR PLASTIC BUTTONS 1 MAINTAINED, 1 MOMENTARY DPDT FORM-C CONTACTS ON 1-GANG SS PLATE	\$192.00
5260-LMP24-25*	TWO ILLUMINATED PLASTIC BUTTONS 1 MAINTAINED, 1 MOMENTARY DPDT FORM-C CONTACTS ON 1-GANG SS PLATE	\$290.00
(SUFFIX)		
xAT	<u>5276 SERIES OPTIONS ADD TO ABOVE</u>	(ADD)
xFT	ADJUSTABLE 1 - 60 SEC. TIMER DPDT OUTPUT	\$135.00
	FIXED 30 SECOND TIMER DPDT RELAY OUTPUT	\$135.00
-R	* DESIGNATES RED BUTTON CAP	N/C
-G	* DESIGNATES GREEN BUTTON CAP	N/C
xCOV	CLEAR FLIP UP PROTECTIVE LENS COVER	\$22.00
(PREFIX)		
N	ADD NARROW 1-3/4" PLATE FOR FRAME MOUNTING	\$12.00
D	ADD DOUBLE GANG SWITCH PLATE	\$24.00
(SUFFIX)		
xE1	<u>TEXT OPTIONS</u>	
xE6	PLATE TEXT "PUSH TO EXIT"	\$24.00
	PER PLATE FEE AFTER SET UP	\$30.00
	CUSTOM TEXT 1 SET UP FEE PER RUN	\$80.00

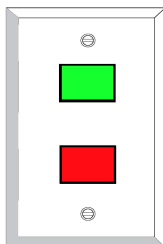

5260-2/25/RG

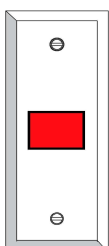

N5260-25/R

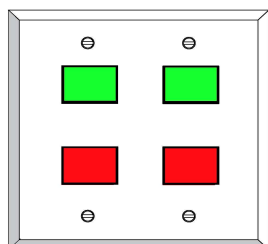

D5260-2/25-2/24/RG

(ORDER AS LINE ITEM)---- XE6SETUP

ACTUATORS



5276 SERIES

PART # DESCRIPTION LIST PRICE

1" DIAMETER PUSH BUTTONS

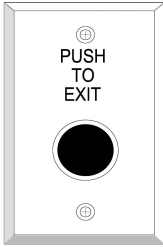

5276-GP9xE1



N5276-GP9xE2

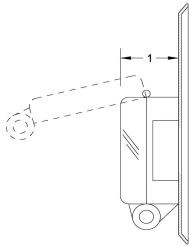

xCOV

(ORDER AS LINE ITEM)----

PART #	DESCRIPTION	LIST PRICE
5276-GP SERIES 1" GUARDED PUSH BUTTONS		
5276-GP8-*	ALTERNATE ACTION PUSH BUTTON SWITCH DPST GUARD MOUNTED ON SINGLE GANG PLATE	\$158.00
5276-GP9-*	MOMENTARY ACTION PUSH BUTTON SWITCH DPST GUARD MOUNTED ON SINGLE GANG PLATE	\$96.00
5276-GP23DA-*	PNEUMATIC 2-60 SEC. DELAY (FORM Z) GUARDED	\$306.00

(SUFFIX)	5276 SERIES OPTIONS ADD TO ABOVE	(ADD)
xAT	ADJUSTABLE 1 - 60 SEC. TIMER DPDT OUTPUT	\$135.00
xFT	FIXED 30 SECOND TIMER DPDT RELAY OUTPUT	\$135.00
xL	BI-COLOR LED HEAVY DUTY CHROME BEZEL	\$42.00
xCOV	HINGED CLEAR PLASTIC LOCKABLE COVER 2" DIA.	\$85.00
(PREFIX)		
N	NARROW 1-3/4" PLATE	\$12.00
D	DOUBLE GANG SWITCH PLATE	\$24.00

(SUFFIX)	AVAILABLE CAP COLORS	
-R	* DESIGNATES RED BUTTON CAP	N/C
-B	* DESIGNATES BLACK BUTTON CAP	N/C
-G	* DESIGNATES GREEN BUTTON CAP (NON STOCK)	N/C

(SUFFIX)	TEXT OPTIONS	
xE1	PLATE TEXT "PUSH TO EXIT"	\$24.00
xE2	PLATE TEXT "PANIC"	\$24.00
xE3	PLATE TEXT "EMERGENCY RELEASE"	\$26.00
xE4	PLATE TEXT "PUSH TO RELEASE"	\$26.00
xE5	PLATE TEXT "EMERGENCY DOOR RELEASE"	\$26.00
xE6	PER PLATE FEE AFTER SET UP	\$30.00
XE6SETUP	CUSTOM TEXT 1 SET UP FEE PER RUN	\$89.00
XHCP	HANDICAP LOGO BLUE TEXT	\$44.00

ACTUATORS



5276 SERIES

PART # DESCRIPTION LIST PRICE

WEATHER PROOF HEAVY DUTY



WR5276-HD22XE8

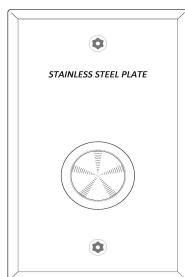

WR5276-HD28

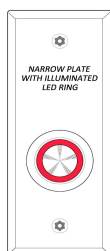

NWR5276-HD28xLRG

(ORDER AS LINE ITEM)----

<u>PART #</u>	<u>DESCRIPTION</u>	<u>LIST PRICE</u>
<u>WR5276-HD22 SS BUTTONS</u>		
WR5276-HD22	5/8" ROUND STAINLESS WEATHER PROOF BUTTON IP66 RATED w/ DPNO MOMENTARY CONTACTS MOUNTED ON SINGLE GANG SS PLATE	\$178.00
NWR5276-HD22	5/8" ROUND STAINLESS WEATHER PROOF BUTTON IP66 RATED w/ DPNO MOMENTARY CONTACTS MOUNTED ON 1-3/4" NARROW SS PLATE	\$190.00
<u>1GANG WR5276 SS BUTTONS</u>		
WR5276-HD28	3/4" ROUND STAINLESS BUTTON WEATHER PROOF IP65 w/ DPST MAINTAIN (1-NO & 1-NC CONTACT) MOUNTED ON SINGLE GANG SS PLATE	\$185.00
WR5276-HD29	3/4" ROUND STAINLESS BUTTON WEATHER PROOF IP65 w/ DPST MOMENTARY (1-NO & 1-NC CONTACT) MOUNTED ON SINGLE GANG SS PLATE	\$185.00
<u>1 GANG ILLUMINATED WR5276 SS BUTTONS</u>		
WR5276-HD28 xLRG	3/4" ROUND STAINLESS BUTTON w/ ILLUMINATED LED RING WEATHER PROOF IP65 w/ DPST MAINTAIN (1-NO & 1-NC CONTACT) 1 GANG SS PLATE	\$195.00
WR5276-HD29 xLRG	3/4" ROUND STAINLESS BUTTON w/ ILLUMINATED LED RING WEATHER PROOF IP65 w/ DPST MOMENTARY (1- NO & 1-NC CONTACT) 1 GANG SS PLATE	\$195.00
<u>NARROW ILLUMINATED 5276 SS BUTTONS</u>		
		<u>(ADD)</u>
<u>(SUFFIX)</u>		
xAT	1-60 SECOND TIMER DPDT RELAY OUTPUT	\$135.00
xFT	FIXED 30 SECOND TIMER DPDT RELAY OUTPUT	\$135.00
xL	BI-COLOR LED HEAVY DUTY CHROME BEZEL	\$60.00
<u>(PREFIX)</u>		
D	DOUBLE GANG SWITCH PLATE	\$24.00
N	NARROW 1-3/4" MULLION PLATE	\$12.00
<u>(SUFFIX)</u>	<u>TEXT OPTIONS</u>	
xE1	PLATE TEXT "PUSH TO EXIT"	\$24.00
xE2	PLATE TEXT "PANIC"	\$24.00
xE3	PLATE TEXT "EMERGENCY RELEASE"	\$26.00
xE4	PLATE TEXT "PUSH TO RELEASE"	\$26.00
xE5	PLATE TEXT "EMERGENCY DOOR RELEASE"	\$26.00
xE6	PER PLATE FEE AFTER SET UP	\$30.00
xE7	PLATE TEXT "PUSH TO ENTER"	\$24.00
xE8	PLATE TEXT "DOOR BELL"	\$24.00
XHCP	HANDICAP LOGO BLUE TEXT	\$44.00
XHCP2	HANDICAP LOGO BLUE TEXT	\$60.00
XE6SETUP	CUSTOM TEXT 1 SET UP FEE PER RUN	\$80.00



ACTUATORS

5277 SERIES PIEZOELECTRIC SWITCHES

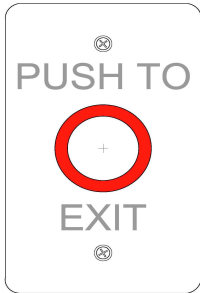

W5277-PZLXE1

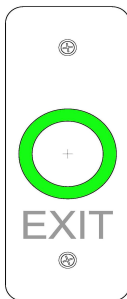

PART #	DESCRIPTION	LIST PRICE
5277 SERIES PIEZOELECTRIC SWITCHES		
W5277-PZL	TIME DELAY (1-60 SECOND) PIEZO SWITCH 1 SET N.O. 1 SET N.C. CONTACTS WITH ILLUMINATED BI COLOR LED RING MOUNTED ON STANDARD STAINLESS STEEL 1 GANG PLATE COMPLETELY SEALED FOR WEATHER RESISTANCE	\$315.00
N5277-PZL	TIME DELAY (1-60 SECOND) PIEZO SWITCH 1 SET N.O. 1 SET N.C. CONTACTS WITH ILLUMINATED BI COLOR LED RING MOUNTED ON NARROW 1-3/4" STAINLESS STEEL PLATE COMPLETELY SEALED FOR WEATHER RESISTANCE	\$315.00
<u>(SUFFIX)</u>	5277 TEXT (ADD)	<u>(ADD)</u>
xE1	ADD "PUSH TO EXIT" IN RED LETTERS (W Series only)	\$40.00
xE3	ADD "EXIT" IN RED LETTERS CUSTOM TEXT NOT AVAILABLE FOR THIS SERIES	\$40.00
SS500351	SS SURFACE BOX 1-3/4 FOR "W" 5277	\$98.00
SSN500351	SS NARROW SURFACE BOX 1-3/4 FOR "N" 5277	\$88.00

5278 SERIES TOUCHLESS ELECTRIC SWITCHES

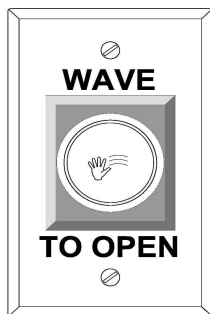

W5278-25XE1W

PART #	DESCRIPTION	LIST PRICE
5278 SERIES TOUCHLESS ELECTRIC SWITCHES		
W5278-25	INFRARED PROXIMITY ACTIVATED SWITCH DOUBLE POLE DOUBLE THROW RELAY CONTACTS WITH ILLUMINATED BI COLOR LED RING MOUNTED ON STAINLESS STEEL 1 GANG PLATE (12VDC)	\$136.00
D5278-25	INFRARED PROXIMITY ACTIVATED SWITCH DOUBLE POLE DOUBLE THROW RELAY CONTACTS WITH ILLUMINATED BI COLOR LED RING MOUNTED ON STAINLESS STEEL 2 GANG PLATE (12VDC)	\$156.00
3311228	DUAL VOLTAGE MODULE CONVERTS 24V TO 12VDC	\$70.00
xAT	ADJUSTABLE 1 - 60 SEC. TIMER DPDT OUTPUT	\$135.00
xFT	FIXED 30 SECOND TIMER DPDT RELAY OUTPUT	\$135.00
<u>(SUFFIX)</u>	5278 STOCK TEXT (ADD)	
xE1W	ADD "WAVE TO OPEN" IN BLACK LETTERS	\$24.00
xE3	ADD "EXIT" IN BLACK LETTERS	\$24.00
xHCP	ADD HANDICAP LOGO WITH "WAVE TO EXIT"	\$26.00
	5278 CUSTOM TEXT (ADD)	
xE6	PER PLATE FEE AFTER SET UP	\$30.00
(ORDER AS LINE ITEM)---- XE6SETUP	CUSTOM TEXT 1 SET UP FEE PER RUN	\$80.00

ACTUATORS



5286 SERIES

<u>PART #</u>	<u>DESCRIPTION</u>	<u>LIST PRICE</u>
PUSH PLATE SWITCHES		
<u>NARROW STYLE PUSH PLATE SWITCHES</u>		
N5286-P24	DPDT MAINTAINED ACTION SWITCH WITH 1-1/2" WIDE PUSH PLATE ON 1-3/4" ALUMINUM BACK PLATE	\$150.00
N5286-P25	DPDT MOMENTARY ACTION SWITCH WITH 1-1/2" WIDE PUSH PLATE ON 1-3/4" ALUMINUM BACK PLATE	\$146.00
N5286-P23DA	PNEUMATIC 2-60 SECOND DELAY (FORM Z) SWITCH WITH 1-1/2" WIDE PUSH PLATE ON 1-3/4" ALUMINUM BACK PLATE	\$352.00
N5286-AT	ADJUSTABLE 2-60 SECOND TIMER DPDT OUTPUT	\$282.00
N5286-FT	FIXED 30 SECOND TIMER DPDT RELAY OUTPUT	\$282.00
N5286-ET	ADJUSTABLE 2-60 SEC. EXIT TIMER DPDT OUTPUT	\$350.00
<u>SINGLE GANG PUSH PLATE SWITCHES</u>		
W5286-P24	DPDT MAINTAINED ACTION SWITCH WITH 1-1/2" WIDE PUSH PLATE ON 3" WIDE ALUMINUM BACK PLATE	\$150.00
W5286-P25	DPDT MOMENTARY ACTION SWITCH WITH 1-1/2" WIDE PUSH PLATE ON 3" WIDE ALUMINUM BACK PLATE	\$146.00
W5286-P23DA	PNEUMATIC 2-60 SEC. DELAY (FORM Z) SWITCH WITH 1-1/2" WIDE PUSH PLATE ON 3" WIDE BACK PLATE	\$348.00
W5286-AT	ADJUSTABLE 2-60 SECOND TIMER DPDT OUTPUT	\$282.00
W5286-FT	FIXED 30 SECOND TIMER DPDT RELAY OUTPUT	\$282.00
W5286-ET	ADJUSTABLE 2-60 SEC. EXIT TIMER DPDT OUTPUT	\$350.00
<u>DOUBLE GANG PUSH PLATE SWITCHES</u>		
D5286-P24	DPDT MAINTAINED ACTION SWITCH WITH 4" WIDE PUSH PLATE ON 4-5/8" WIDE ALUMINUM BACK PLATE	\$190.00
D5286-P25	DPDT MOMENTARY ACTION SWITCH WITH 4" WIDE PUSH PLATE ON 4-5/8" WIDE ALUMINUM BACK PLATE	\$188.00
D5286-P23DA	PNEUMATIC 2 - 60 SEC. DELAY (FORM Z) SWITCH WITH 4" PUSH PLATE ON 4-5/8" WIDE BACK PLATE	\$370.00
D5286-AT	ADJUSTABLE 2-60 SECOND TIMER DPDT OUTPUT	\$324.00
D5286-FT	FIXED 30 SECOND TIMER DPDT RELAY OUTPUT	\$324.00
D5286-ET	ADJUSTABLE 2-60 SEC. EXIT TIMER DPDT OUTPUT	\$380.00
(SUFFIX)		(ADD)
xL	ADD 1 LED BLACK BEZEL (BICOLOR RED / GREEN) RECESSED INTO PUSH PAD (NOT AVAILABLE ON "D" SERIES)	\$40.00



N5286-P25xE1

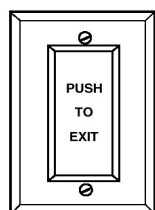

W5286-P25xE1

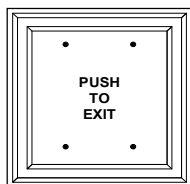

D5286-P25xE1

***** PLEASE SEE PAGE 29 FOR ENGRAVING & FINISH OPTIONS*****

ACTUATORS



5286 SERIES

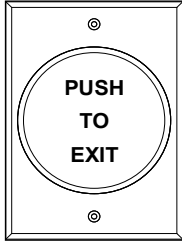

R5286-P25xE1

<u>PART #</u>	<u>DESCRIPTION</u>	<u>LIST PRICE</u>
ROUND PUSH PLATE SWITCHES		
<u>ROUND PUSH PLATE SWITCHES</u>		
R5286-P24	DPDT MAINTAINED ACTION SWITCH WITH 2-1/2" ROUND PALM BUTTON ON 3" WIDE ALUMINUM BACK PLATE	\$166.00
R5286-P25	DPDT MOMENTARY ACTION SWITCH WITH 2-1/2" ROUND PALM BUTTON ON 3" WIDE ALUMINUM BACK PLATE	\$162.00
R5286-P23DA	PNEUMATIC 2-60 SECOND DELAY (FORM Z) SWITCH WITH 2-1/2" ROUND PALM BUTTON ON 3" WIDE ALUMINUM BACK PLATE	\$362.00
R5286-AT	ADJUSTABLE 2-60 SECOND TIMER DPDT OUTPUT	\$296.00
R5286-FT	FIXED 30 SECOND TIMER DPDT RELAY OUTPUT	\$296.00
R5286-ET	ADJUSTABLE 2-60 SEC. EXIT TIMER DPDT OUTPUT	\$354.00
<u>(SUFFIX)</u>		<u>(ADD)</u>
xL	ADD 1 LED BLACK BEZEL (BICOLOR RED / GREEN)	\$22.00

***** PLEASE SEE NEXT PAGE FOR ENGRAVING & FINISH OPTIONS*****

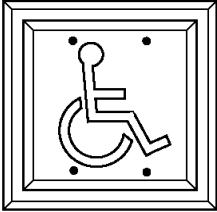

ACTUATORS

	<u>PART #</u>	<u>DESCRIPTION</u>	<u>LIST PRICE</u>
5286 SERIES		CUSTOM FINISHES & ENGRAVING	
		<u>5286 STOCK ENGRAVING (ADD)</u>	
	<u>(SUFFIX)</u>		<u>(ADD)</u>
	xE1	ADD "PUSH TO EXIT" IN BLACK LETTERS	\$20.00
	xE1R	ADD "PUSH TO EXIT" IN RED LETTERS	\$20.00
	xE2	ADD "PANIC" IN RED LETTERS	\$20.00
	xE3	ADD "EXIT" IN RED LETTERS	\$20.00
	xE4	ADD "DOOR RELEASE" IN BLACK LETTERS	\$20.00
	xE5	ADD "EMERGENCY DOOR RELEASE" IN RED LETTERS	\$22.00
	xE6	PER PLATE FEE AFTER SET UP	\$30.00
(ORDER AS LINE ITEM)----	XE6SETUP	CUSTOM ENGRAVING 1 SET UP FEE PER RUN	\$80.00
	<u>(SUFFIX)</u>	<u>5286 STANDARD HANDICAP LOGOS</u>	<u>(ADD)</u>
	xHCP	ADD FOR BLUE LOGO ON CLEAR ALUMINUM ONLY	\$46.00
	xHCP2	ADD FOR BLUE LOGO W/ "PUSH TO OPEN" ON CLEAR ALUMINUM	\$56.00
	xHCP3	ADD FOR WHITE LOGO ON BLUE PLATE W / "PUSH TO OPEN" ENGRAVED (D-SERIES ONLY)	\$110.00
			
D5286-P25xHCP			
	<u>(SUFFIX)</u>	<u>5286 SERIES FINISH OPTIONS</u>	<u>(ADD)</u>
	xBRE	ADD FOR RED FINISH (NON-STOCK)	\$60.00
	xDBA	ADD FOR DARK BRONZE ANODIZED (STOCKED) (IF BUTTON IS XBRE OR XDBA TEXT IS WHITE)	\$60.00
	xUS26	ADD FOR POLISHED CHROME -	
	xUS26D	ADD FOR SATIN CHROME -	
	xUS3	ADD FOR POLISHED BRASS -	
	xUS4	ADD FOR SATIN BRASS -	
		ALL PLATED FINISHES - (N,W & R SERIES)	\$330.00
		ALL PLATED FINISHES - (D SERIES)	\$350.00

ACTUATORS



5287 SERIES

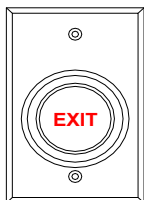

W5287xE3

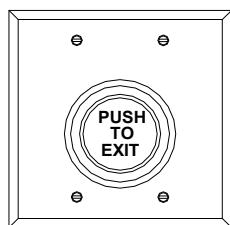

D5287xE1

(ORDER AS LINE ITEM)-----

PART #	DESCRIPTION	LIST PRICE
HEAVY DUTY PUSH BUTTON SWITCHES		
<u>SINGLE GANG PUSH BUTTON SWITCHES</u>		
W5287-P24	DPDT MAINTAINED ACTION SWITCH WITH 1-1/2" DIAMETER BUTTON ON ALUMINUM BACK PLATE	\$194.00
W5287-P25	DPDT MOMENTARY ACTION SWITCH WITH 1-1/2" DIAMETER BUTTON ON ALUMINUM BACK PLATE	\$196.00
W5287-P23DA	PNEUMATIC 2 - 60 SEC. DELAY (FORM Z) SWITCH WITH 1-1/2" DIAMETER BUTTON ON ALUMINUM BACK PLATE	\$380.00
W5287-AT	ADJUSTABLE 1 - 60 SECOND TIMER DPDT OUTPUT WITH 1-1/2" DIAMETER BUTTON ON ALUMINUM BACK PLATE	\$330.00
W5287-FT	FIXED 30 SECOND TIMER DPDT OUTPUT WITH 1-1/2" DIAMETER BUTTON ON 3" WIDE ALUMINUM BACK PLATE	\$330.00
W5287-ET	ADJUSTABLE 1 - 60 SECOND EXIT TIMER DPDT OUTPUT WITH 1-1/2" DIAMETER BUTTON ON ALUMINUM BACK PLATE	\$386.00
<u>DOUBLE GANG PUSH PLATE SWITCHES</u>		
D5287-	CHANGE "W" TO "D" TO SPECIFY A DOUBLE GANG 4-5/8" WIDE ALUMINUM BACK PLATE WITH 1-1/2" DIAMETER BUTTON	(ADD) \$50.00
(SUFFIX)	<u>5287 STOCK ENGRAVING (ADD):</u>	(ADD)
xE1	ADD "PUSH TO EXIT" IN BLACK LETTERS	\$20.00
xE1R	ADD "PUSH TO EXIT" IN RED LETTERS	\$20.00
xE3	ADD "EXIT" IN RED LETTERS	\$20.00
xE6	PER PLATE FEE AFTER SET UP	\$30.00
XE6SETUP	CUSTOM ENGRAVING 1 SET UP FEE PER RUN	\$80.00
<u>5287 STANDARD HANDICAP LOGOS</u>		
xHCP	ADD HANDICAP BLUE LOGO ON CLEAR ALUMINUM	\$46.00
xHCP3	ADD HANDICAP WHITE LOGO ON BLUE ALUMINUM	\$66.00
(SUFFIX)	<u>5287 SERIES FINISH OPTIONS</u>	(ADD)
xDBA	ADD FOR DARK BRONZE ANODIZED	\$60.00
xBRE	ANODIZED RED FINISH (ON BUTTON ONLY) BACK PLATE CLEAR ANODIZED OR PLATED FINISH (IF BUTTON IS XBRE XSBA OR XDBA TEXT IS WHITE)	\$60.00
xUS26	ADD FOR POLISHED CHROME -	
xUS26D	ADD FOR SATIN CHROME -	
xUS3	ADD FOR POLISHED BRASS -	
xUS4	ADD FOR SATIN BRASS -	
	ALL PLATED FINISHES - (W SERIES)	\$330.00
	ALL PLATED FINISHES - (D SERIES)	\$350.00
(SUFFIX)		(ADD)
xL	ADD 1 LED (BICOLOR RED / GREEN) CHROME BEZEL FOR HEAVY DUTY SERIES	\$60.00

ACCESSORIES



6200 SERIES	PART #	DESCRIPTION	LIST PRICE
	DOOR CORD		

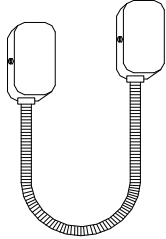

	6220	6200 SERIES DOOR CORD 18" ARMORED DOOR CORD WITH SURFACE MOUNT J-BOX 1-5/8" WIDE x 3" LONG x 1-1/8" DEEP (INCLUDES 4 CONDUCTOR 22 AWG CABLE) STANDARD COLOR ALUMINUM	\$80.00
	(SUFFIX)	ARMORED DOOR CORD FINISHES (ADD):	
	xDBA	ADD FOR DARK BRONZE COLORED CORD AND J-BOX ARMORED DOOR CORD	N/C

A DOOR CORD IS TYPICALLY REQUIRED TO TRANSFER POWER TO AN EGRESS BAR

6400 SERIES	EGRESS BARS
--------------------	--------------------



		6400 SERIES EGRESS SWITCH BARS	
	6420-S25	EGRESS BAR FOR 36" DOOR WITH DUAL SPDT SWITCHES STANDARD ALUMINUM FINISH	\$630.00
	6495	RIM STYLE MECHANICAL LATCHING FOR 36" DOOR UL LISTED PANIC DEVICE (NO SWITCH)	\$515.00
	6495-S25	RIM STYLE MECHANICAL LATCHING FOR 36" DOOR PANIC DEVICE WITH 2 SPDT SWITCHES	\$650.00
	(SUFFIX)	WEATHERPROOF SWITCHES	(ADD)
	xWR	DUAL SEALED WEATHERPROOF SPDT SWITCHES FOR OUTDOOR APPLICATIONS	\$100.00
	(SUFFIX)	EGRESS BAR SPECIAL FINISHES:	(ADD)
	xDBA	ADD FOR DARK BRONZE ANODIZED FINISH	\$20.00
	X48	ADD FOR DOORS OVER 36" UP TO 48" (NON STOCK)	\$50.00



ACCESSORIES

6500 SERIES

PART # DESCRIPTION LIST PRICE

EMERGENCY PULL STATIONS

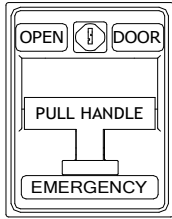

PART #	DESCRIPTION	LIST PRICE
6510/*-S35	PULL STATION W/ TWO SPDT (FORM C) SWITCHES	\$190.00
6510/*-S35xCS	PULL STATION W/ TWO SPDT (FORM C) SWITCHES WITH LOCAL PIEZO 12-24VDC	\$225.00
* SPECIFY COLOR: /BL = BLUE ENAMEL FINISH /BK = BLACK ENAMEL FINISH /YL = YELLOW ENAMEL FINISH		

SURFACE MOUNT COLORED BACK BOXES

4-7/8 H x 3-1/2 W x 2" D

6510/BX-BK	BLACK SURFACE MOUNT BACK BOX	\$85.00
6510/BX-BL	BLUE SURFACE MOUNT BACK BOX	\$85.00
6510/BX-YL	YELLOW SURFACE MOUNT BACK BOX	\$85.00



6510/COV

6510 SERIES ANTI TAMPER COVERS

FLUSH MOUNT STYLE 2-1/2" DEEP ID

6510/COV	4-7/8"W x 5-1/2"H x 2-1/2"D LIFT TO ACCESS PULL	\$170.00
6510/COV/S	SAME AS ABOVE WITH PIEZO ALARM SOUNDER	\$288.00
6510/COV/SR	ANTI-TAMPER COVER W/SOUNDER & SPDT RELAY	\$350.00

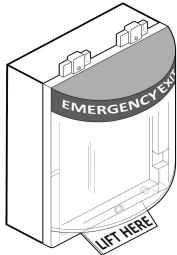

6510/COV-X

SURFACE MOUNT STYLE 3-7/8" DEEP ID
W/ EXTENSION FOR USE WITH 6510 BACK BOX

6510/COV-X	4-7/8"W x 5-1/2"H x 3-7/8"D LIFT TO ACCESS PULL	\$200.00
6510/COV/S-X	SAME AS ABOVE WITH PIEZO ALARM SOUNDER	\$325.00
6510/COV/SR-X	ANTI-TAMPER COVER W/SOUNDER & SPDT RELAY	\$450.00

(ORDER AS LINE ITEM)----	(SUFFIX)
	XE6SETUP
	XE6
	651000K
	6510/BR
	65-1280

ACCESSORIES

	(ADD)
CUSTOM LABELING SETUP	\$80.00
PER UNIT FEE AFTER SET UP	\$20.00
SPARE KEY FOR 6510-S35 PULL	\$16.00
BREAK RODS 12 PER PACK	\$24.00
BACK PLATE FOR 6510/COV ,COV/S & COV/SR FOR MOUNTING TO UNEVEN SURFACE	\$38.00

6600 SERIES

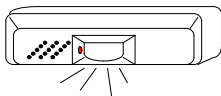

MOTION DETECTORS



6612	UL LISTED REQUEST-TO-EXIT PIR MOTION DETECTOR (12/24 VDC) w/ ADJUSTABLE (1-120 SECOND) TIME DELAY IN A SLIM LINE 7.1" x 1.65" x 1.65" IVORY COLORED CASE (ONE DPDT FORM C ALARM OUTPUT)	\$500.00
------	---	----------

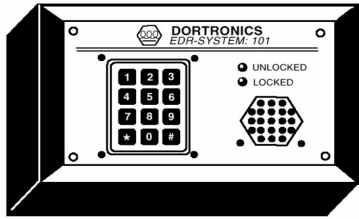
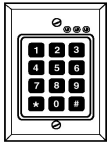
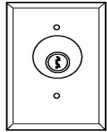

ANNUNCIATORS

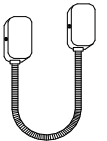
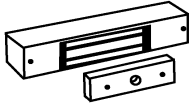
7101 SERIES	PART #	DESCRIPTION	LIST PRICE
	7101-P	EDR SYSTEM-101 CONTROLLER EDR-101 DELAYED EGRESS CONTROL PANEL KEYPAD CONSOLE, AUDIBLE ALERT, 3 SECOND NUISANCE / 15 SECOND ALARM DELAY, PROGRAMMABLE CLOCK / DAY SCHEDULER, 3 STATUS OUTPUTS, PROGRAMMABLE ESCORT CODE FOR KEYPAD (OR OPTIONAL KEY SWITCH) INCLUDES 12 VDC 1 AMP POWER SUPPLY, WITH 9 VOLT RECHARGEABLE BATTERY, 3 GANG S/S FLUSH MOUNT PLATE, 3 GANG (IVORY) SURFACE MOUNT BOX, AND 20 FOOT LONG HOOK-UP CABLES	\$1,630.00
			
	7101-KP	EDR SYSTEM-101 ACCESSORIES: AUXILIARY KEYPAD - SUPPLIED WITH 15 FOOT CABLE, WEATHER RESISTANT FOR AUTHORIZED ACCESS FROM SECURED SIDE	\$530.00
			
	5141-24xK	DPDT MAINTAINED KEY SWITCH - EDR-101 ALARM SHUNT / BY-PASS SEE PAGE 19 FOR DETAILED DESCRIPTION	\$220.00
			
	5216-MP23xE3	PUSH BUTTON SWITCH - EMERGENCY RELEASE SEE PAGE 20 FOR DETAILED DESCRIPTION	\$162.00
			
	6420-S25	EGRESS BAR w/ TWO SPDT SWITCHES (ACTIVATES EDR-101 & HAS 1 EXTRA OUTPUT) SEE PAGE 32 FOR DETAILS	\$630.00
			
	6220	6200 SERIES DOOR CORD 18" ARMORED DOOR CORD WITH SURFACE MOUNT J-BOX (INCLUDES 4 CONDUCTOR 22 AWG CABLE) STANDARD COLOR ALUMINUM	\$80.00
			
	1110xD	SINGLE DOOR 1200 LB LOCK w/ DOOR SWITCH (FOR USE w/ EDR-101 & 6420-S25 EGRESS BAR RELEASE)	\$770.00
			
	1107xEDR	SINGLE DOOR 600 LB LOCK w/ DPS & ATTEMPTED EGRESS SWITCH (FOR USE w/ EXISTING HDWR.)	\$828.00
	1110xEDR	SINGLE DOOR 1200 LB LOCK w/ DPS & ATTEMPTED EGRESS SWITCH (FOR USE w/ EXISTING HDWR.)	\$970.00
		NOTE: FOR DOUBLE DOORS USE TWO (2) LOCKS WHICH MAY REQUIRE ADDITIONAL POWER @12V	

ANNUNCIATORS



7201 SERIES

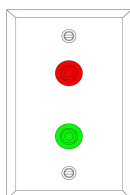

7201xL2-H

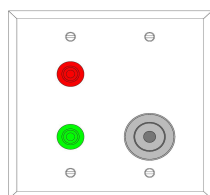

7202xL2-HxCS

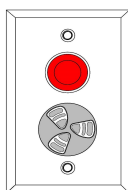

7201xL1R-HWRxCWSW

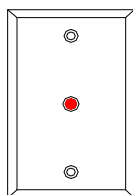

7201xL1

(ORDER AS LINE ITEM)----

PART #	DESCRIPTION	LIST PRICE
HI-INTENSITY LED INDICATORS		
	7201-H HI-INTENSITY LEDS 11/16" DIA.	
7201xL1*-H	1 HIGH INTENSITY LED MOUNTED ON 1 GANG STAINLESS STEEL PLATE	\$84.00
7201xL1*-HxCS	1 HIGH INTENSITY LED & 1 PIEZO SOUNDER MOUNTED ON 1 GANG STAINLESS STEEL PLATE	\$114.00
7201xL2-H	1 EACH RED/GREEN HIGH INTENSITY LED MOUNTED ON 1 GANG STAINLESS STEEL PLATE	\$132.00
7202xL2-HxCS	1 EACH RED/GREEN HIGH INTENSITY LED & 1 PIEZO SOUNDER MOUNTED ON A 2 GANG STAINLESS STEEL PLATE	\$190.00
	* SPECIFY LED COLOR R=RED G=GREEN	
	7201-HWR WATER PROOF HI-INTENSITY LEDS 1" DIA.	
7201xL1*-HWR	1 WATER PROOF HIGH INTENSITY LED MOUNTED ON A 1 GANG STAINLESS STEEL PLATE	\$84.00
7201xL1*-HWRxCWSW	1 WATER PROOF HIGH INTENSITY LED 1 WATER PROOF (12VDC) PIEZO MOUNTED ON A 1 GANG STAINLESS STEEL PLATE	\$128.00
7201xL2-HWR	1 EACH WATER PROOF RED/GREEN HIGH INTENSITY LED MOUNTED ON A 1 GANG STAINLESS STEEL PLATE	\$132.00
7202xL2-HWRxCWSW	1 EACH WATER PROOF RED/GREEN HIGH INTENSITY LED 1 WATER PROOF (12VDC)PIEZO MOUNTED ON A 2 GANG STAINLESS STEEL PLATE	\$182.00
STANDARD LED INDICATORS		
	7201 STANDARD LEDS SMALL DIA. 3/16"	
7201xL1	1 BICOLOR LED WITH CHROME BEZEL MOUNTED ON A 1 GANG STAINLESS STEEL PLATE	\$92.00
7201xL2	2 BICOLOR LEDS WITH CHROME BEZEL MOUNTED ON A 1 GANG STAINLESS STEEL PLATE	\$120.00
PIEZO SOUNDERS CONTINUOUS 12-24VDC		
7201xCS	PIEZO CONTINUOUS SOUNDER ON 1 GANG SS	\$60.00
7201xCWSW	WATER PROOF PIEZO SOUNDER ON 1 GANG SS	\$90.00
(SUFFIX)	ADD OPTIONAL PIEZO CONTINUOUS SOUNDERS	(ADD)
xCS	ADD PIEZO SOUNDER	\$30.00
xCSW	ADD WATER PROOF PIEZO SOUNDER	\$60.00
xCSW-A	ADD WATER PROOF PIEZO W/ADJ. VOLUME	\$80.00
(SUFFIX)	ADD OPTIONAL LEDS	(ADD)
xL	ADD FOR EACH BICOLOR LED W/CHROME BEZEL	\$42.00
xL-H	ADD FOR EACH HIGH INTENSITY LED	\$60.00
xL-HWR	ADD FOR WATER PROOF HIGH INTENSITY LED	\$66.00
(SUFFIX)	ADD OPTIONAL SWITCHES	(ADD)
xT24	ADD FOR EACH DPDT-MAINTAINED TOGGLE	\$68.00
xT25	ADD FOR EACH DPDT-MOMENTARY TOGGLE	\$68.00
xP14	ADD FOR EACH SPDT-MAINT.PUSH BUTTON	\$34.00
xP15	ADD FOR EACH SPDT-MOM PUSH BUTTON	\$36.00
xP25	ADD FOR EACH DPDT-MOM PUSH BUTTON	\$65.00
	ADD CUSTOM ENGRAVING	
xE6	PER PLATE FEE AFTER SET UP	\$30.00
(ORDER AS LINE ITEM)---- XE6SETUP	CUSTOM ENGRAVING 1 SET UP FEE PER RUN	\$80.00
(PREFIX)	ADD OPTIONAL MOUNTING PLATES	(ADD)
D	DOUBLE GANG SWITCH PLATE	\$24.00
N	NARROW 1-3/4" PLATE FOR FRAME MOUNTING	\$12.00



ANNUNCIATORS

7200 SERIES MULTI-ZONE ANNUNCIATORS

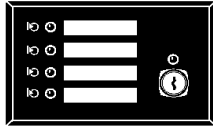

7204

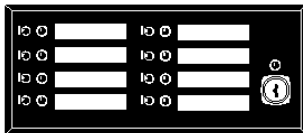

7208

PART #	DESCRIPTION	LIST PRICE
7200 SERIES CUSTOM ANNUNCIATORS		
7204	3 GANG PLATE WITH 4-ZONE OVERLAY ADD FOR LEDS, TOGGLE SWITCHES, PUSH BUTTONS, KEYSWITCH AND SOUNDER - COMPONENTS ALL HAVE FLYING LEADS (NO LOGIC OR TERMINALS INCLUDED)	\$400.00
7204	3 GANG PLATE WITHOUT 4-ZONE OVERLAY STAINLESS STEEL PLATE ADD PARTS & ENGRAVING	\$210.00
7208	4 GANG PLATE WITH 8-ZONE OVERLAY ADD FOR LEDS, TOGGLE SWITCHES, PUSH BUTTONS, KEYSWITCH AND SOUNDER - COMPONENTS ALL HAVE FLYING LEADS (NO LOGIC OR TERMINALS INCLUDED)	\$435.00
7208	4 GANG PLATE WITHOUT 4-ZONE OVERLAY STAINLESS STEEL PLATE ADD PARTS & ENGRAVING	\$260.00
8 + ZONE PANELS ADD \$30.00 FOR EACH ZONE OVER 8 ZONES		EA. ZONE \$30
NOTE: CUSTOM & RACK MOUNT CONFIGURATIONS AVAILABLE TO SUIT INDIVIDUAL APPLICATIONS		(Call for quote)
7202-ENCL	SLOPED DESK TOP CONSOLE 2 GANG PLATE	\$430.00
7604-8-ENCL	9 X 6 X 3-1/2" DESK TOP CONSOLE 4-8 ZONES	\$600.00
7612-16-ENCL	15 X 6 X 3-1/2" DESK TOP CONSOLE 12-16 ZONES	\$720.00

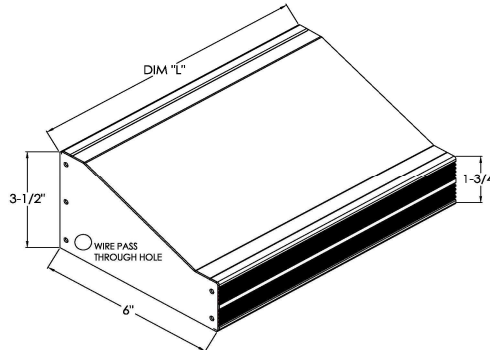

(SUFFIX)	7200 SERIES ADD ON COMPONENTS	(ADD)
xL	ADD FOR EACH BICOLOR LED W/CHROME BEZEL	\$42.00
xT24	ADD FOR EACH DPDT-MAINT.TOGGLE SWITCH	\$80.00
xT25	ADD FOR EACH DPDT-MOM.TOGGLE SWITCH	\$80.00
xP14	ADD FOR EACH SPDT-MAINT.PUSH BUTTON	\$40.00
xP15	ADD FOR EACH SPDT-MOM. PUSH BUTTON	\$40.00
xP24	ADD FOR EACH DPDT-MAINT. PUSH BUTTON	\$70.00
xP25	ADD FOR EACH DPDT-MOM. PUSH BUTTON	\$70.00
xCS	ADD PIEZO SOUNDER	\$40.00
xK24	ADD SPDT MAINTAINED KEY SWITCH	\$80.00
xTERM	10 POSITION DOUBLE ROW TERMINAL 6 1/2"	\$50.00
ADD CUSTOM ENGRAVING		
xE6	FOR STAINLESS 3&4 GANG PLATES WITHOUT OVERLAY PER PLATE FEE AFTER SET UP (1 word per zone)	\$120.00
	ADD PER GANG FEE OVER 4 GANG PLATE	\$60.00
	CUSTOM ENGRAVING 1 SET UP FEE PER RUN	\$180.00

(ORDER AS LINE ITEM)---- XE6SETUP

NOTE: 7200 SERIES ANNUNCIATORS ARE SUPPLIED WITH FLYING LEADS ONLY.

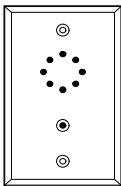
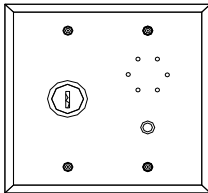
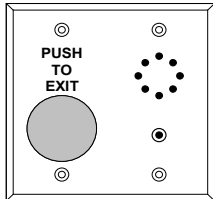
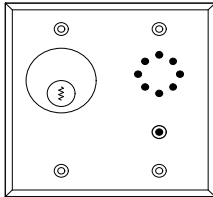

ANNUNCIATORS

	<u>PART #</u>	<u>DESCRIPTION</u>	<u>LIST PRICE</u>
7281 SERIES		LOCAL DOOR EXIT ALARMS	
	7281-EA	<u>EXIT ALARM</u> DOOR ALARM WITH ADJUSTABLE (2 TO 60 SECONDS) DELAY, ALARM OUTPUT (DPDT) RELAY, TRI-STATE LED, AND LOCAL ALARM PIEZO (RESET ON DOOR RE-SECURE) ON STANDARD SINGLE GANG PLATE	\$460.00
7281-EA			
	7281-EAxK332	<u>EXIT ALARM WITH KEY SWITCH RESET</u> DOOR ALARM WITH ADJUSTABLE (2 TO 60 SECONDS) DELAY, ALARM OUTPUT (DPDT) RELAY, TRI-STATE LED, AND LOCAL ALARM PIEZO RESET BY DPDT MAINTAINED ELECTRIC KEYSWITCH PROVIDED. KEY REMOVABLE IN 2 POSITIONS ON STANDARD DOUBLE GANG PLATE	\$540.00
7281-EAxK332			
	7281-EAxMP23	<u>EXIT ALARM WITH PUSH BUTTON</u> DOOR ALARM WITH ADJUSTABLE (2 TO 60 SECONDS) DELAY, ALARM OUTPUT (DPDT) RELAY, TRI-STATE LED, AND LOCAL ALARM PIEZO (RESET ON DOOR RE-SECURE). INCLUDES MOMENTARY REX BUTTON 1-9/16" DIAMETER ON STANDARD DOUBLE GANG PLATE	\$580.00
7281-EAxMP23xE1			
	7281-EAxK24	<u>EXIT ALARM FOR MORTISE CYLINDER</u> DOOR ALARM WITH ADJUSTABLE (2 TO 60 SECONDS) DELAY, TRI-STATE LED, ALARM OUTPUT (DPDT) RELAY WITH LOCAL ALARM PIEZO (RE-SET BY MORTISE KEY SWITCH), INCLUDES 2 (DPDT) KEY SWITCH CONTACTS 1 MOMENTARY 1 MAINTAINED FOR ALARM SHUNT OR RESET ON DOUBLE GANG PLATE (CYLINDER NOT INCLUDED ADD "XK" PER OPTIONS BELOW)	\$570.00
7281-EA-K24xK			
	<u>(SUFFIX)</u>	<u>7281 EXIT ALARM OPTIONS</u>	<u>(ADD)</u>
	xCT	COVER TAMPER SWITCH SPDT	\$70.00
	xK	STANDARD 1-1/8" MORTISE CYLINDER & 2 KEYS	\$70.00
	<u>(SUFFIX)</u>	<u>7281-EAxMP23 ENGRAVING OPTIONS</u>	<u>(ADD)</u>
	xE1	"PUSH TO EXIT" (RED TEXT)	\$24.00
	xE5	"EMERGENCY DOOR RELEASE" (RED TEXT)	\$26.00
	<u>ADD CUSTOM ENGRAVING</u>		
	xE6	PER PLATE FEE AFTER SET UP	\$30.00
(ORDER AS LINE ITEM)---- XE6SETUP		CUSTOM ENGRAVING 1 SET UP FEE PER RUN	\$80.00

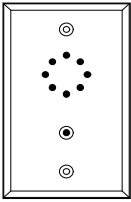
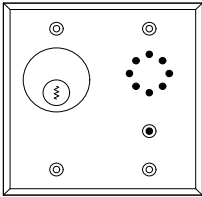
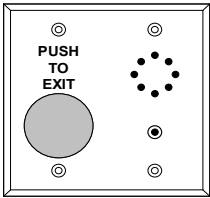

ANNUNCIATORS

	<u>PART #</u>	<u>DESCRIPTION</u>	<u>LIST PRICE</u>
7286 SERIES		LOCAL DOOR PROP ALARMS	
	7286-PT5	<u>LOCAL DOOR PROP ALARM</u> DOOR PROP ALARM WITH ADJUSTABLE (0-SECONDS TO 90-MINUTES) DOOR OPEN DELAY, ALARM OUTPUT (DPDT) RELAY, TRI-STATE LED, AND LOCAL ALARM PIEZO, ADJUSTABLE LOCAL WARNING TIME DELAY & MIRRORED DOOR SWITCH OUTPUT	\$855.00
7286-PT5			
	7286-PT5-24	<u>DOOR PROP ALARM WITH KEY SWITCH</u> DOOR PROP ALARM WITH ADJUSTABLE (0-SECONDS TO 90-MINUTES) DOOR OPEN DELAY, TRI-STATE LED, ALARM OUTPUT (DPDT) RELAY WITH LOCAL ALARM PIEZO, ADJUSTABLE LOCAL WARNING TIME DELAY & MIRRORED DOOR SWITCH OUTPUT (RE-SET BY TIMER, DOOR RE-SECURE OR KEY SWITCH), INCLUDES 2 (DPDT) KEY SWITCH CONTACTS 1 MOMENTARY 1 MAINTAINED FOR ALARM SHUNT OR ALARM RESET ON DOUBLE GANG PLATE (CYLINDER NOT INCLUDED ADD "XK" PER OPTIONS BELOW)	\$980.00
7286-PT5-24xK SHOWN			
	7286-PT5xMP23	<u>DOOR PROP ALARM WITH PUSH BUTTON</u> DOOR PROP ALARM WITH ADJUSTABLE (0-SECONDS TO 90-MINUTES) DOOR OPEN DELAY, TRI-STATE LED, ALARM OUTPUT (DPDT) RELAY WITH LOCAL ALARM PIEZO, ADJUSTABLE LOCAL WARNING TIME DELAY & MIRRORED DOOR SWITCH OUTPUT (AUTOMATIC ALARM RESET BY TIMER OR DOOR RE-SECURE), AND MOMENTARY ACTION PUSH BUTTON SWITCH (1-NO/1-NC) ON DOUBLE GANG PLATE	\$940.00
7286-PT5xMP23xE1 SHOWN			
	<u>(SUFFIX)</u>	<u>7286 DOOR PROP ALARM OPTIONS</u>	<u>(ADD)</u>
	xCT	COVER TAMPER SWITCH SPDT	\$70.00
	xK	STANDARD 1-1/8" MORTISE CYLINDER & 2 KEYS	\$70.00
	<u>(SUFFIX)</u>	<u>7286xMP23 ENGRAVING OPTIONS</u>	<u>(ADD)</u>
	xE1	"PUSH TO EXIT" (RED TEXT)	\$24.00
	xE5	"EMERGENCY DOOR RELEASE" (RED TEXT)	\$26.00
	xE6	<u>ADD CUSTOM ENGRAVING</u> PER PLATE FEE AFTER SET UP	\$30.00
(ORDER AS LINE ITEM)----	XE6SETUP	CUSTOM ENGRAVING 1 SET UP FEE PER RUN	\$80.00



ANNUNCIATORS

7600 SERIES **PART #** **DESCRIPTION** **LIST PRICE**
MULTI-ZONE ANNUNCIATOR/CONTROLLERS

7600 ANNUNCIATOR MULTI-GANG CONSOLES

ANNUNCIATOR/CONTROLLER WITH LED INDICATORS & TOGGLE SWITCHES FOR EACH ZONE. SECURITY KEY SWITCH FOR LED TEST, NORMAL CONTROL, RESTRICTED OPERATION, AND SILENCED ALERT SOUNDER MODE. CONFIGURED IN FOUR ZONE INCREMENTS MOUNTED ON MULTI-GANG STAINLESS STEEL SWITCH PLATES OR 19" WIDE RACK MOUNTABLE PLATES WITH BLACK OVERLAY SUITABLE FOR FLUSH MOUNTING.

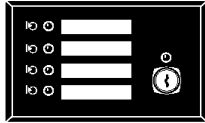

7604-H

7604-H **4 ZONE HARDWIRED ANNUNCIATOR/CONTROLLER ON THREE GANG PLATE (6-1/2" WIDE x 4-1/2" HIGH x 2-1/2" DEEP)** **\$1,600.00**

4 ZONE EXPANSION **ADD (TO #7604 ABOVE) FOR EACH ADDITIONAL 4 ZONE EXPANSION MODULE (EXAMPLES BELOW)** **\$680.00**

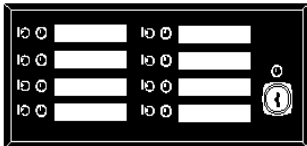

7608-H

#7608-H = **\$2,280.00** (EIGHT ZONES TOTAL)
 #7612-H = **\$2,960.00** (TWELVE ZONES TOTAL)
 #7616-H = **\$3,640.00** (SIXTEEN ZONES TOTAL)
 #7620-H = **\$4,320.00** (TWENTY ZONES TOTAL)

760006-K **SPARE KEY FOR 7600 ANNUNCIATOR** **\$40.00**
 *******MINIMUM OF 2 KEYS PER ORDER*******
 ALL 7600'S HAVE 2 ORIGINAL KEYS SUPPLIED
 MULTIPLE UNITS MAY BE SPECIFIED KEYED ALIKE

DESK TOP ANNUNCIATOR ENCLOSURES

7600 SERIES SLOPED FACE ENCLOSURES:

ALUMINUM CONSTRUCTION SATIN BLACK POWDER COAT FINISH

7604-8-ENCL **9 x 6 x 3-1/2"** **DESKTOP SLOPE FACE ENCLOSURE FOR FOUR OR EIGHT ZONE CONSOLES** **\$600.00**
7612-16-ENCL **15 x 6 x 3-1/2"** **DESKTOP SLOPE FACE ENCLOSURE FOR TWELVE OR SIXTEEN ZONE CONSOLES** **\$720.00**
7620-24-ENCL **19 x 6 x 3-1/2"** **DESKTOP SLOPE FACE ENCLOSURE FOR TWENTY OR TWENTY FOUR ZONE CONSOLES** **\$990.00**

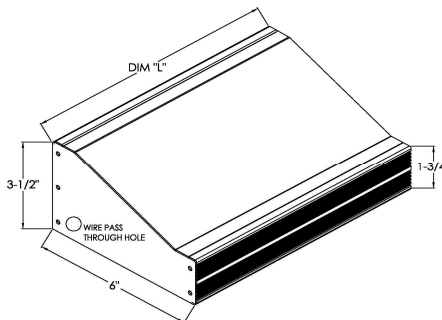



ANNUNCIATORS

7600 SERIES

PART #
ANNUNCIATOR DIMENSIONS

DESCRIPTION

LIST PRICE

7600 SERIES MOUNTING PLATE SIZES:

Model #	Plate Width x Height	Plate Type	Zones
#7604	6-1/2" x 4-1/2"	3-GANG SWITCH PLATE	(4-Zones)
#7608	8-1/4" x 4-1/2"	4-GANG SWITCH PLATE	(8-Zones)
#7612	11-3/4" x 4-1/2"	6-GANG SWITCH PLATE	(12-Zones)
#7616	13-1/2" x 4-1/2"	7-GANG SWITCH PLATE	(16-Zones)
#7620	17-1/2" x 4-1/2"	9-GANG SWITCH PLATE	(20-Zones)

SUFFIX	7604 THRU 7620 OPTIONAL RACK MOUNT PLATE	LIST PRICE
xRM	MOUNTED ON RACK MOUNT PLATE '19" x 5-1/4"	ADD \$200.00

NO ADDITIONAL CHARGE FOR 7624 & LARGER RACK MOUNT PLATES

Model #	Plate Width x Height	Plate Type	Zones
#7624	19" x 5-1/4"	RACK MOUNT PLATE	(24-Zones)
#7628 *	19" x 7"	RACK MOUNT PLATE	(28-Zones)
#7632	19" x 7"	RACK MOUNT PLATE	(32-Zones)
#7636	19" x 10-1/2"	RACK MOUNT PLATE	(36-Zones)
#7640	19" x 7"	RACK MOUNT PLATE	(40-Zones)
#7644 *	19" x 10-1/2"	RACK MOUNT PLATE	(44-Zones)
#7648	19" x 9-1/4"	RACK MOUNT PLATE	(48-Zones)
#7652 *	19" x 10-1/2"	RACK MOUNT PLATE	(52-Zones)
#7656 *	19" x 10-1/2"	RACK MOUNT PLATE	(56-Zones)
#7660	19" x 10-1/2"	RACK MOUNT PLATE	(60-Zones)
#7664	19" x 12-1/4"	RACK MOUNT PLATE	(64-Zones)
#7668 *	19" x 18-1/2"	RACK MOUNT PLATE	(68-Zones)
#7672	19" x 18-1/2"	RACK MOUNT PLATE	(72-Zones)
#7676 *	19" x 12-1/4"	RACK MOUNT PLATE	(76-Zones)
#7680	19" x 12-1/4"	RACK MOUNT PLATE	(80-Zones)
#7684 *	19" x 18-1/2"	RACK MOUNT PLATE	(84-Zones)
#7688 *	19" x 18-1/2"	RACK MOUNT PLATE	(88-Zones)
#7692 *	19" x 18-1/2"	RACK MOUNT PLATE	(92-Zones)
#7696	19" x 18-1/2"	RACK MOUNT PLATE	(96-Zones)
#76100	19" x 15-1/4"	RACK MOUNT PLATE	(100-Zones)
#76104	19" x 18-1/2"	RACK MOUNT PLATE	(104-Zones)
#76108	19" x 18-1/2"	RACK MOUNT PLATE	(108-Zones)
#76112	19" x 18-1/2"	RACK MOUNT PLATE	(112-Zones)
#76116	19" x 18-1/2"	RACK MOUNT PLATE	(116-Zones)
#76120	19" x 18-1/2"	RACK MOUNT PLATE	(120-Zones)

ELECTRICAL BACK BOXES FOR FLUSH WALL MOUNTING

700353	3 GANG BACK BOX FOR 7604-H	\$85.00
700354	4 GANG BACK BOX FOR 7608-H	\$110.00
700356	6 GANG BACK BOX FOR 7612-H	\$150.00

*Due to the physical layout of these units there may be additional zones which will be plugged on the plate with black plastic inserts to match the black overlay

ACCESS CONTROL



8100 SERIES

PART # DESCRIPTION

KEYPAD ACCESS CONTROLS

LIST PRICE

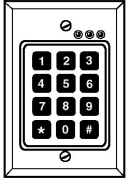

8112

PART #	DESCRIPTION	LIST PRICE
8112	8112 SERIES DIGITAL KEY PADS USER PROGRAMMABLE DIGITAL KEY PAD SINGLE DOOR STAND-ALONE ACCESS CONTROL 120 USER CODES PROGRAMMED FROM KEYPAD 1 TO 90 SECONDS ADJUSTABLE TIME DELAY (RECOMMENDED FOR INTERIOR APPLICATIONS)	\$400.00
8112-WR	WEATHER RESISTANT MEMBRANE KEY PAD SINGLE DOOR STAND-ALONE ACCESS CONTROL 120 USER CODES PROGRAMMED FROM KEYPAD 1 TO 90 SECONDS ADJUSTABLE TIME DELAY	\$400.00
WR500351	WEATHER RESISTANT SURFACE MOUNT SINGLE GANG BOX FOR USE WITH 8112-WR	\$50.00

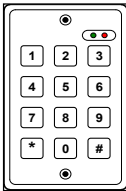

8160

PART #	DESCRIPTION	LIST PRICE
8160xINT	8160 SERIES HEAVY DUTY DIGITAL KEY PADS HEAVY DUTY, ALL METAL, TOUCH SENSITIVE, WEATHERPROOF, KEYPAD SINGLE DOOR STAND ALONE ACCESS CONTROL WITH 200 ACTIVE USER CODES INTEGRATED UNIT SINGLE GANG MOUNT WITH ON-BOARD ELECTRONICS 200 USER CODES SPDT. RELAY OUTPUT N.O. PUSH BUTTON SWITCH INPUT	\$560.00

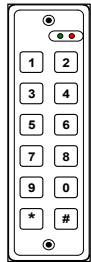

8160xNS

8160xNSxINT	NARROW INTEGRATED UNIT 1-3/4" WIDE WITH ON-BOARD ELECTRONICS 200 USER CODES SPDT. RELAY OUTPUT N.O. PUSH BUTTON SWITCH INPUT	\$560.00
-------------	---	----------

REPLACEMENT PARTS



MAG LOCK

<u>PART #</u>	<u>DESCRIPTION</u>	<u>LIST PRICE</u>
---------------	--------------------	-------------------

REPLACEMENT PARTS

MAGLOCK REPLACEMENT PARTS

MOUNTING KITS

1000701	LOCK MOUNTING KIT 1000 SERIES	\$16.00
1000702	TJ LOCK MOUNTING KIT 1000 SERIES	\$15.00
1100701	LOCK MOUNT KIT 1106,1107,1110,1150	\$12.50
1100702	TJ-LOCK MOUNT KIT TJ1106,TJ1107,TJ1110,TJ1150	\$13.00
1100721	DOUBLE LOCK MOUNTING KIT 1120, 1152	\$13.50
1100722	DOUBLE TJ-LOCK MOUNTING KIT TJ1120, TJ1152	\$14.50
1100703	ARMATURE MOUNTING KIT 1-3/4" DOOR	\$32.00
1100703.2	ARMATURE MOUNTING KIT 2" DOOR	\$58.00
1100703.25	ARMATURE MOUNTING KIT 2-1/4" DOOR	\$58.00
1100703.3	ARMATURE MOUNTING KIT 3" DOOR	\$94.00
1100703.325	ARMATURE MOUNTING KIT 3-1/4" DOOR	\$94.00
1100703-SC	ARMATURE MOUNTING KIT FOR XEDR LOCKS	\$18.00
1100704	TJ- ARMATURE MOUNTING KIT	\$21.00

ARMATURES

1000051	1000 SERIES ARMATURE	\$125.00
1000054	1000 DPS ARMATURE W/ACTUATING MAGNET	\$145.00
1106051	1106 & 1107 SERIES ARMATURE	\$75.00
1106054-RD	1106 & 1107 DPS ARMATURE W/ACTUATING MAGNET	\$90.00
1115051	1115 SERIES ARMATURE	\$70.00
1115054	1115 DPS ARMATURE W/ACTUATING MAGNET	\$86.00
1110051	1110 SERIES ARMATURE	\$115.00
1110054-RD	1110 DPS ARMATURE W/ACTUATING MAGNET	\$144.00
1160011	DPS ACTUATING MAGNET ONLY	\$15.00
1160015	DPS SWITCH ONLY SPDT W/LEADS	\$38.00
1610051	1150 SERIES ARMATURE WITH OR WITHOUT MBS	\$130.00
1610054	1150 DPS ARMATURE W/ACTUATING MAGNET	\$158.00
1610155	1155 SERIES ARMATURE	\$95.00
1610154	1155 DPS ARMATURE W/ACTUATING MAGNET	\$105.00

SURFACE MOUNT PLATE FOR ARMATURE

(INCLUDES REQUIRED MOUNTING HARDWARE)

1110050	FOR 1000,1110,1150 (2 REQ. FOR 1120/1152/1155)	\$165.00
1115050	FOR 1107 (2 REQUIRED FOR 1115 SERIES)	\$184.00

"Z" BRACKETS

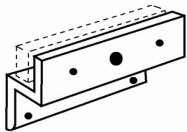

TOP JAMB Z-BRACKETS w/ MOUNTING KIT

1096-00	Z-BRACKET FOR 1000 "TJ" LOCKS	\$120.00
1196-06	Z-BRACKET FOR 1107 "TJ" LOCKS	\$110.00
1196-10	Z-BRACKET FOR 1110 "TJ" LOCKS	\$130.00
1196-15L	Z-BRACKET FOR 1115 "TJ" LOCKS	\$105.00
1196-15R	Z-BRACKET FOR 1115 "TJ" LOCKS	\$105.00
1196-50	Z-BRACKET FOR 1150 "TJ" LOCKS	\$140.00
1196-55L	Z-BRACKET FOR 1155 "TJ" LOCKS	\$115.00
1196-55R	Z-BRACKET FOR 1155 "TJ" LOCKS	\$115.00
1196703	Z-BRACKET MOUNTING KIT	\$35.00

(SUFFIX)

xDBA	ADD FOR DARK BRONZE ANODIZED Z-BRACKET	\$90.00
xUS3	ADD FOR POLISHED BRASS Z-BRACKET	\$295.00
xUS26	ADD FOR POLISHED CHROME Z-BRACKET	\$295.00
xUS4	ADD FOR SATIN BRASS Z-BRACKET	\$295.00
xUS26D	ADD FOR SATIN CHROME Z-BRACKET	\$295.00

Z- BRACKET SPECIAL FINISHES



REPLACEMENT PARTS

<u>PART #</u>	<u>DESCRIPTION</u>	<u>LIST PRICE</u>
SWITCH REPLACEMENT PARTS		
5140 SERIES PARTS		
5141090	CYLINDER W/ 2 KEYS FOR 5141 SERIES	\$70.00
5141703	CYLINDER MOUNTING KIT FOR 5141 KEY SWITCH	\$24.00
5215 SERIES SWITCHES		
5215015	SPDT MOM ACTION SW. 8" LEADS	\$30.00
5230 SERIES SWITCHES		
5230014L	SPDT MAINTAINED SNAP ACTION SW. 8" LEADS	\$36.00
5230015L	SPDT MOMENTARY SNAP ACTION SW. 8" LEADS	\$36.00
5230024L	DPDT MAINTAINED SNAP ACTION SW. 8" LEADS	\$65.00
5230025L	DPDT MOMENTARY SNAP ACTION SW. 8" LEADS	\$60.00
5140 & 5280 SERIES SWITCHES		
<i>(SPECIFY IF REPLACEMENT SWITCH IS FOR A KEY SWITCH OR A PUSH BUTTON)</i>		
5280024L	DPDT MAINTAIN ACTION SWITCH W/8" LEADS	\$62.00
5280025L	DPDT MOMENTARY ACTION SWITCH W/8" LEADS	\$62.00
5280024T	DPDT MAINTAIN TOGGLE SWITCH W/8" LEADS	\$68.00
5280025T	DPDT MOMENTARY TOGGLE SWITCH W/8" LEADS	\$94.00
TIME DELAY REPLACEMENT PARTS		
5220023L	PNEUMATIC 2-60 SEC. TIME DELAY SWITCH	\$280.00
52800AT	AT ADJUSTABLE 2-60 SEC.TIMER DPDT 12/24 VDC	\$135.00
52800FT	FT FIXED 30 SEC.TIMER DPDT 12/24 VDC	\$135.00
52800ET	ET TIMER 2-60 SEC. DPDT 12/24 VDC	\$190.00
ELECTRICAL BOXES & ACCESSORIES		
500351	1-GANG STANDARD ELECTRICAL BOX	\$50.00
500352	2-GANG STANDARD ELECTRICAL BOX	\$80.00
WR500351	1-GANG WEATHER RESISTANT ELECTRICAL BOX	\$50.00
WR500352	2-GANG WEATHER RESISTANT ELECTRICAL BOX	\$75.00
N500351	NARROW 1-3/4" JAMB MOUNT BACK BOX BLACK HIGH IMPACT PLASTIC CONSTRUCTION	\$70.00
SS500351	SS 1 GANG SURFACE BOX FOR 5277 SERIES	\$98.00
SSN500351	SS NARROW SURFACE BOX 1-3/4 FOR"N" 5277	\$88.00
LED REPLACEMENT PARTS		
7020251	BLACK PLASTIC BEZEL (BICOLOR RED / GREEN) W/6" LEADS	\$20.00
7020256	CHROME BEZEL FOR HD AND 7200 SERIES ANNUNCIATORS (BICOLOR RED / GREEN)	\$42.00
7020252-HI	HI INTENSITY RED W/6" LEADS	\$70.00
7020255-HI	HI INTENSITY GREEN W/6" LEADS	\$70.00
7020252-HI-WR	WEATHER PROOF HI INTENSITY RED 6" LEADS	\$75.00
7020255-HI-WR	WEATHER PROOF HI INTENSITY GREEN 6" LEADS	\$75.00
MISC. REPLACEMENT PARTS		
1100640	xCT COVER TAMPER REPLACEMENT SWITCH	\$40.00
6410015-J	6420 / 6495 SERIES SPDT REPLACEMENT SWITCH (2 REQUIRED PER DEVICE)	\$50.00
6410015-J-WR	WEATHER PROOF SWITCH FOR SAME AS ABOVE	\$60.00
LA-LABEL DOOR SIGN 15-30	DELAYED EGRESS NFPA 101 SIGNAGE	\$14.00



SALES – POLICIES, PROCEDURES & WARRANTY

Orders may be placed with one of our

Distributors:

<https://dortronics.com/find-a-distributor/>

Contact our local Sales Representative for
purchasing options:

<https://dortronics.com/sales-representation/>

To Open an Account:

A credit application which includes bank, trade references, Dunn & Bradstreet rating and company information, is filled out and returned for processing. If customer is approved, they are set up on a Net-30 Day Terms with a credit limit based on the outcome of the credit check. Typically, first orders are cod, Credit card or Cash in advance. Credit cards accepted are: Visa, Mastercard, Discover and American Express.

Freight Policy:

Terms are **FOB (Sag Harbor NY)** FOB is a shipping term that stands for “free on board.” If a shipment is designated FOB (the seller’s location), then as soon as the shipment of goods leaves the seller’s warehouse, the seller records the sale as complete. The buyer owns the products en route to its warehouse and must pay any delivery charges. That also means that if product is lost or damaged in shipment, the buyer must file any claims for reimbursement – not the seller – since the shipment became the buyer’s responsibility immediately.

Freight is prepaid and billed on all invoices which are mailed the day after shipment.

Carriers used are UPS, FED-EX and trucking. Customers may use their own shipping account.

Drop ship Info:

No additional charge. Address be advised during verbal phone order, or specified on E-mail or faxed purchase orders.

International Accounts:

The minimum export order is \$250.00. Export orders requiring special handling, packaging, and documentation are subject to additional charges. Export orders are accepted on the basis of payment in advance of shipment by a check in U.S. funds, wire transfer, or credit card. Payment will include costs of Materials, freight, brokerage, bank fees, duty or taxes. Customer may request shipping insurance at additional cost.

Contact (Sales):

Mike Palermo –Customer Service Manager

Patty Bryant – Sales/Customer Service

Skip Burnham - National Sales Manager

Daniel Dermont – Applications Engineer

Janice Wilson – Accounting; New Customer Accounts

Returns:

All claims for shortages must be made within 72 hours of receipt of product.

Any shipping, damaged parts or order discrepancies must be reported within 5 days of receipt.

A Return Authorization Number must be obtained and accompany all returns within 14 days of issue. Products returned without a Return Material Authorization number will not be accepted. All Return Material Authorizations are conditional and are not final until the product is received and inspected by the Company. If warranted credit will be issued at the original price charged less handling and transportation charges, where applicable (see Product Warranties). Unused items returned for credit must be complete and packed in original unit box and are subject to a minimum 15% restocking charge.



Product Warranties

All Electromagnetic locks have a LIFETIME WARRANTY against defects in material and workmanship. Defective units will be replaced or repaired based upon incoming evaluation and inspection.

All other Dortronics components and electronics shall be similarly warranted for a period of one year. Expressed warranties are conditionally based on the requirement that the items covered within the warranty are used and maintained in accordance with the manufacturer's recommendations.

Dortronics sole and maximum liability for breach of its warranties herein is limited to the obligation, at the Company's sole discretion to repair, reprocess or provide replacement goods, or at the Company's discretion credit the Customer's account, any goods delivered hereunder which either become defective or fail to meet the applicable specifications during the warranty period and which are found by the Company to be defective under the terms of this warranty, provided that (a) the Company is notified in writing by the Customer within thirty (30) days after discovery of defects or failure to meet the Specifications; (b) the Customer obtains a Return Material Authorization number from Company prior to returning any defective goods to the Company; (c) the defective goods are returned to the Company, transportation charges prepaid by the Customer (provided, however, that if upon examination by the Company, it determines that the goods are entitled to this warranty, then the Company shall be responsible for all transportation charges to and from the Company's facility); (d) the defective goods are received by the Company for adjustment no later than four (4) weeks following the last day of the warranty period; and (e) the Company's examination of such goods shall disclose that such defects or failures have not been caused by misuse, abuse, neglect, improper installation or application, repair, alteration, damage by rain, fire or casualty or by accident or negligence in use, storage, transportation or handling. In addition, the Company shall have no liability to the Customer to the extent such failure is caused by non-compatibility with other components used by the Customer. In the event that any one or more of the foregoing conditions is not satisfied, the Company shall have no liability under this warranty whatsoever. The Customer has an obligation to mitigate any damages related to integration of defective or non-conforming Parts. If the Customer has knowledge that such Parts are defective or non-conforming or the Company has advised the Customer that Parts are defective or non-conforming and in either event the Customer integrates such defective Parts, the Company shall have no liability to the Customer for any damages incurred by the Customer as a result. In the event that the foregoing exclusive remedy under this warranty is determined upon judicial review to have failed in its essential purpose through no fault of the Customer, the alternate exclusive remedy shall be the refund of the purchase price of the non-conforming or defective goods. Any repairs to or alterations on the goods shipped hereunder must be authorized in writing by the Company to prevent voiding the Company's warranty. The Company's goods may be prohibited for shipment to certain countries, entities or individuals under U.S. export regulations. The Company is not liable to the Customer for any delays or failure to obtain the necessary export license. THE COMPANY'S OBLIGATION TO HONOR THESE WARRANTIES IS CONTINGENT UPON THE COMPANY'S RECEIPT OF PAYMENT IN FULL FOR THE GOODS ENTITLED TO THIS WARRANTY. THE COMPANY DISCLAIMS ALL OTHER WARRANTIES, EXPRESS, IMPLIED, OR STATUTORY, INCLUDING, WITHOUT LIMITATION, THE IMPLIED WARRANTIES OF MERCHANTABILITY AND FITNESS FOR A PARTICULAR PURPOSE. THE COMPANY HAS NOT AUTHORIZED ANYONE TO MAKE ANY REPRESENTATION OR WARRANTY OTHER THAN AS PROVIDED ABOVE. THE FOREGOING STATES THE ENTIRE WARRANTY LIABILITY OF THE COMPANY.



DORTRONICS SYSTEMS, INC.

1668 Sag Harbor Tpke., Sag Harbor, NY 11963 (800) 906-0137 (631) 725-8148 Fax www.dortronics.com

CREDIT APPLICATION

COMPANY NAME: _____ PH: _____
STREET ADDRESS: _____ FX: _____
CITY: _____ STATE: _____ ZIP: _____

PRINCIPALS

TITLE OR POSITION

NAME: _____
NAME: _____
NAME: _____
NAME: _____

BANK: _____ BRANCH: _____
ADDRESS: _____ PH: _____ EXT: _____
CITY: _____ STATE: _____ ZIP: _____
PERSON TO CONTACT: _____ POSITION: _____

AMOUNT OF CREDIT REQUESTED: \$ _____

TRADE REFERENCES

1: _____ 2: _____

PH: _____ FX: _____ PH: _____ FX: _____
ACCOUNT #: _____ ACCOUNT #: _____

3: _____ 4: _____

PH: _____ FX: _____ PH: _____ FX: _____
ACCOUNT #: _____ ACCOUNT #: _____

TERMS & CONDITIONS:

In consideration of credit extended we agree to pay invoices due within 30 days of invoice date.
A 2% interest fee may be applied to past due invoices.

DEFAULT:

In the case of default, all collection charges, Lawyers fees and interest will be borne by the applicant Company.

We understand your terms and conditions as stated above and agree to abide by them in making this application for credit. I also understand that an investigative consumer report may be made.

We hereby authorize the release of any information from the above business references and our bank.

ALL REPLIES WILL BE KEPT CONFIDENTIAL

Signature required below by Company officer or duly authorized representative.

SIGNATURE: _____ TITLE: _____

PRINT NAME: _____ DATE: _____

WHAT YOU WANT - WHEN YOU WANT IT

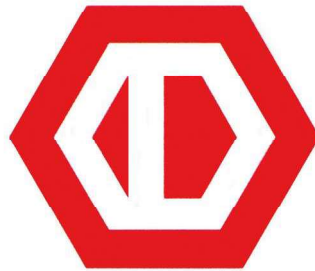

DORTRONICS
SYSTEMS, INC.

Made with pride



1668 SAG HARBOR TURNPIKE SAG HARBOR NY11963
www.dortronics.com • (800) 906-0137 • (631) 725-8148 FAX • sales@dortronics.com