

1 GANG PLATE W/LED

7201XL1

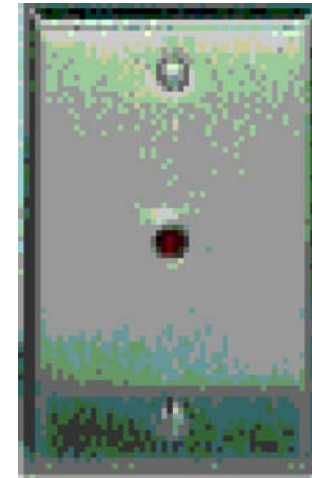
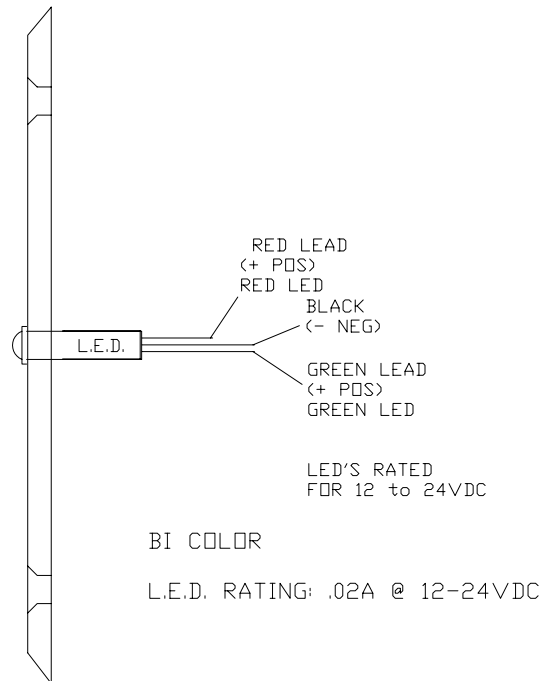
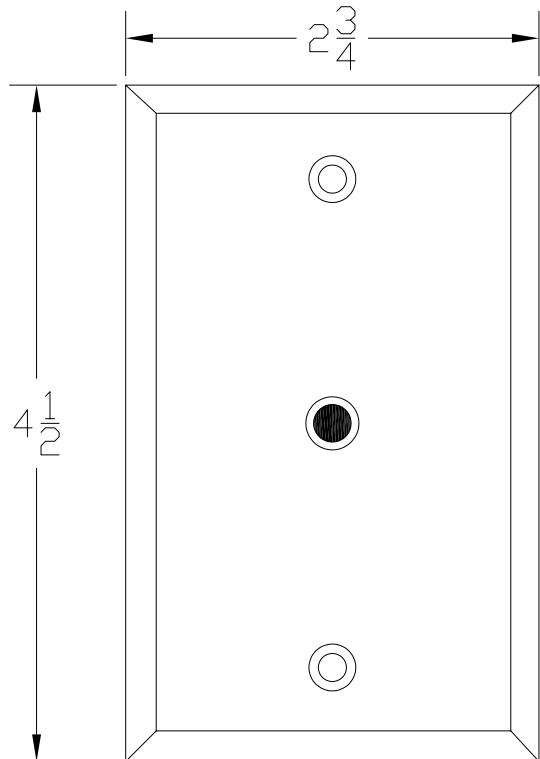

TOLERANCES, (NON-ACCUM):
(UNLESS SPECIFIED)

.XXXXX	: +/- .0025
.XXXX	: +/- .005
.XXX	: +/- .010
.XX	: +/- .015
FRACT	: +/- 1/64
ANGLES	: +/- 1/2 DEG

TITLE				
MATERIAL STAINLESS STEEL			CAD FILE 7201XL1	
FINISH SATIN STAINLESS			SHEET 1 OF 1 SIZE A	
DRAWN JTF	DATE 4/27/04	SCALE TO FIT	DWG. NO.	
APPR. XXX	DATE XX/XX/XX	UNITS INCHES	7201XL1 -	

REV	REVISION DESCRIPTION	DATE
-	-	-

7202xL2-H

2 GANG STAINLESS STEEL PLATE
2 HI-INTENSITY LED'S

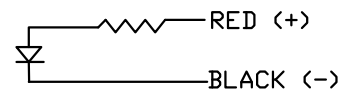
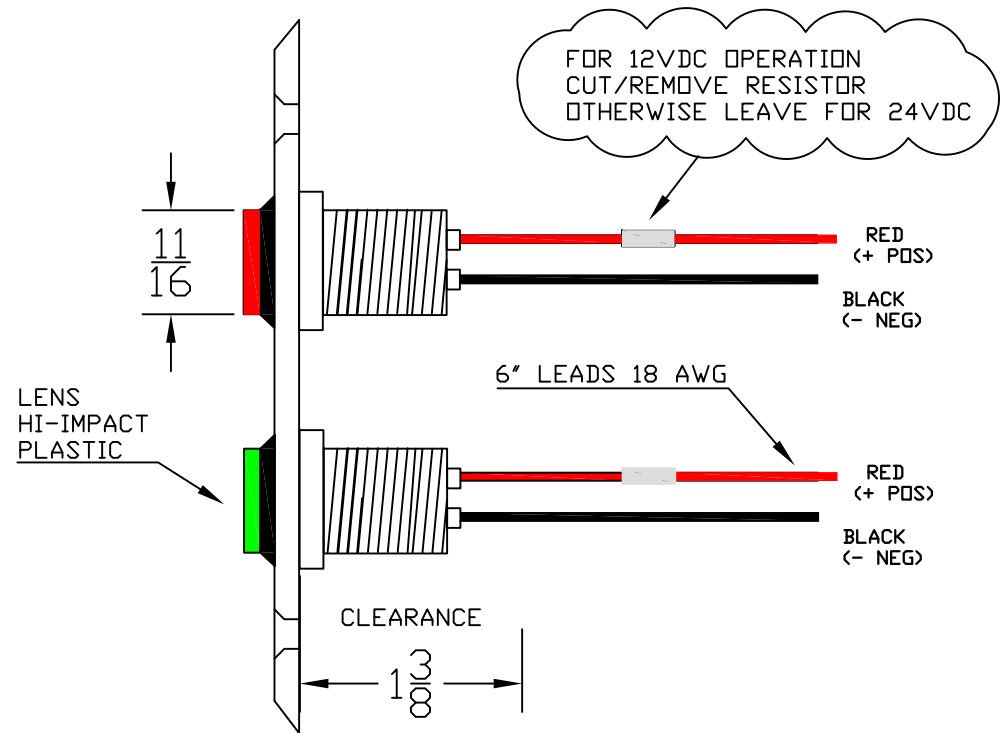
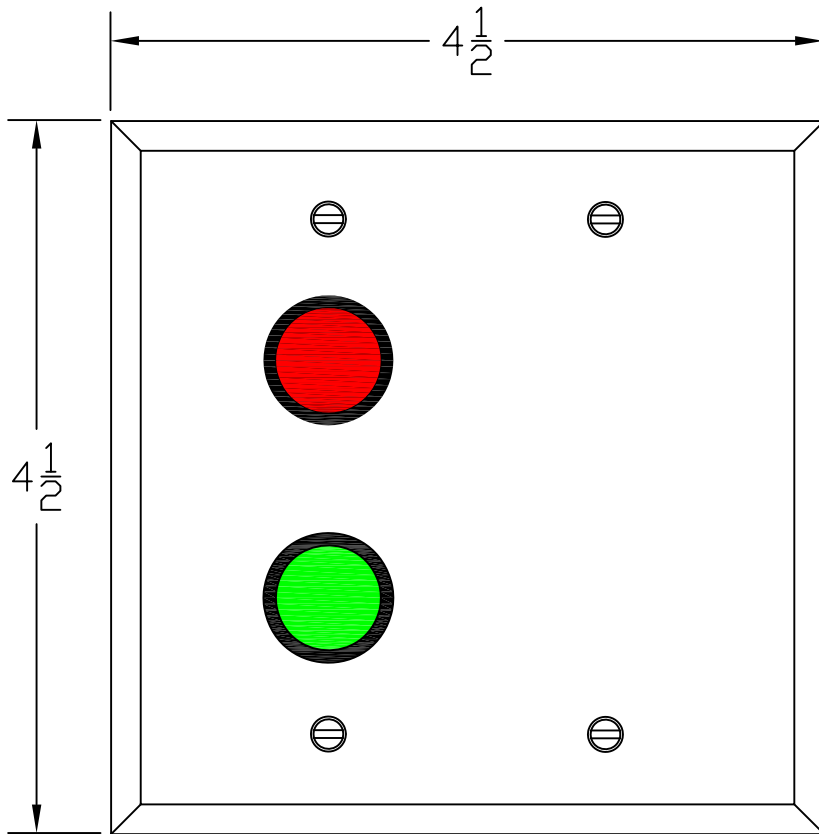

L.E.D. RATING: .04A @ 12-24VDC

 DORTRONICS SYSTEMS, INC.			
		7201XL2-H HI-INTENSITY LED'S	
DATE	9/11/11	FILE	7202XL2-H
DRAWN	JTF	SHEET	1 OF 1 SIZE A

7201xL2-HWR

1 GANG STAINLESS STEEL PLATE
2 HI-INTENSITY WATER PROOF LED'S

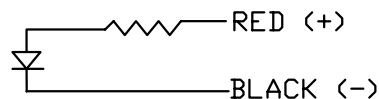
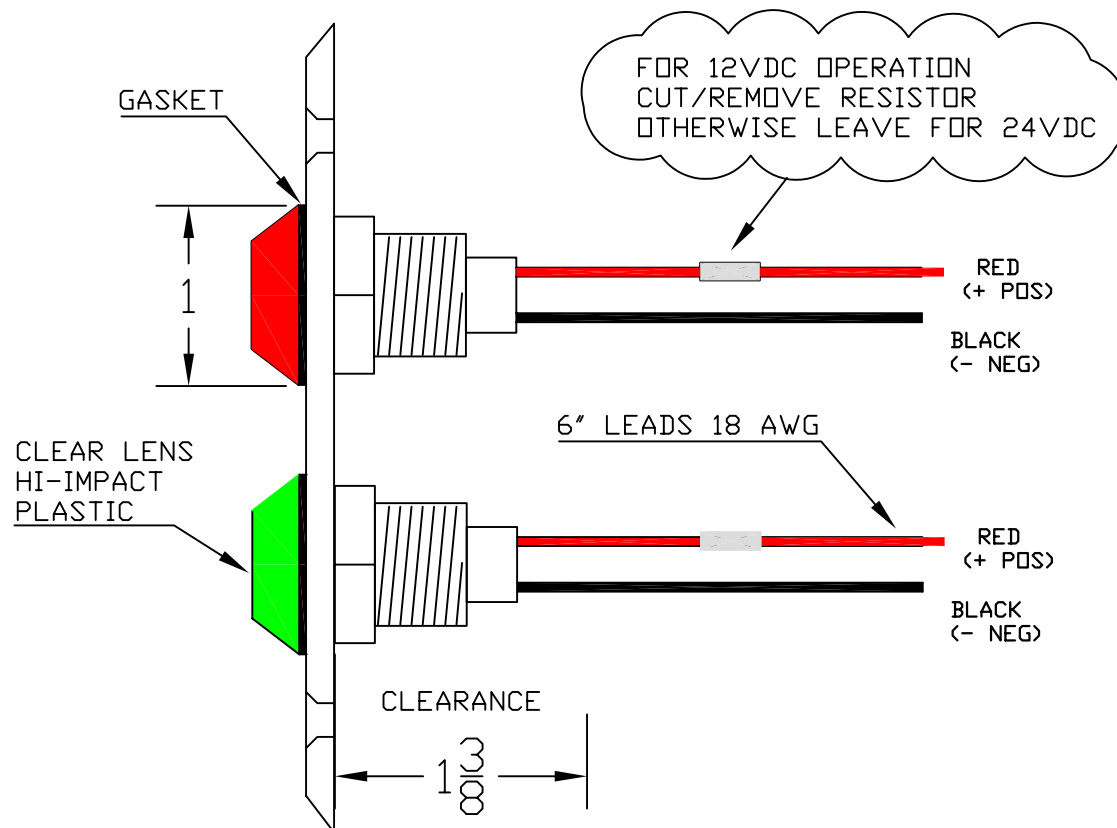
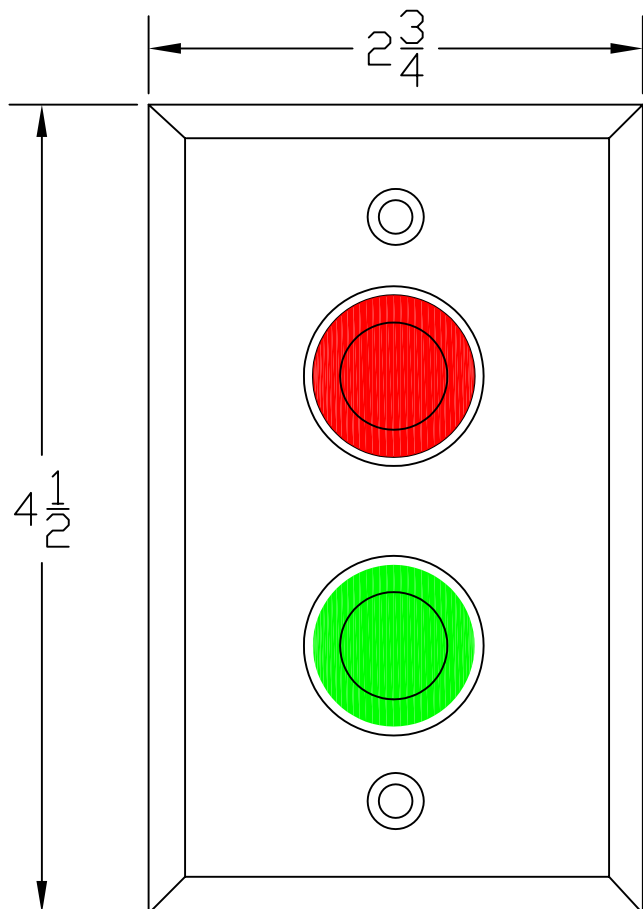

L.E.D. RATING: .04A @ 12-24VDC

 DORTRONICS SYSTEMS, INC.		7201XL2-HWR	
		HI-INTENSITY WATER PROOF LED'S	
DATE	2/12/04	FILE	7201XL2-HWR
DRAWN	JTF	SHEET	1 OF 1 SIZE A

7201xL2-H

1 GANG STAINLESS STEEL PLATE
2 HI-INTENSITY LED'S

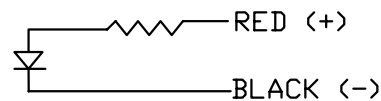
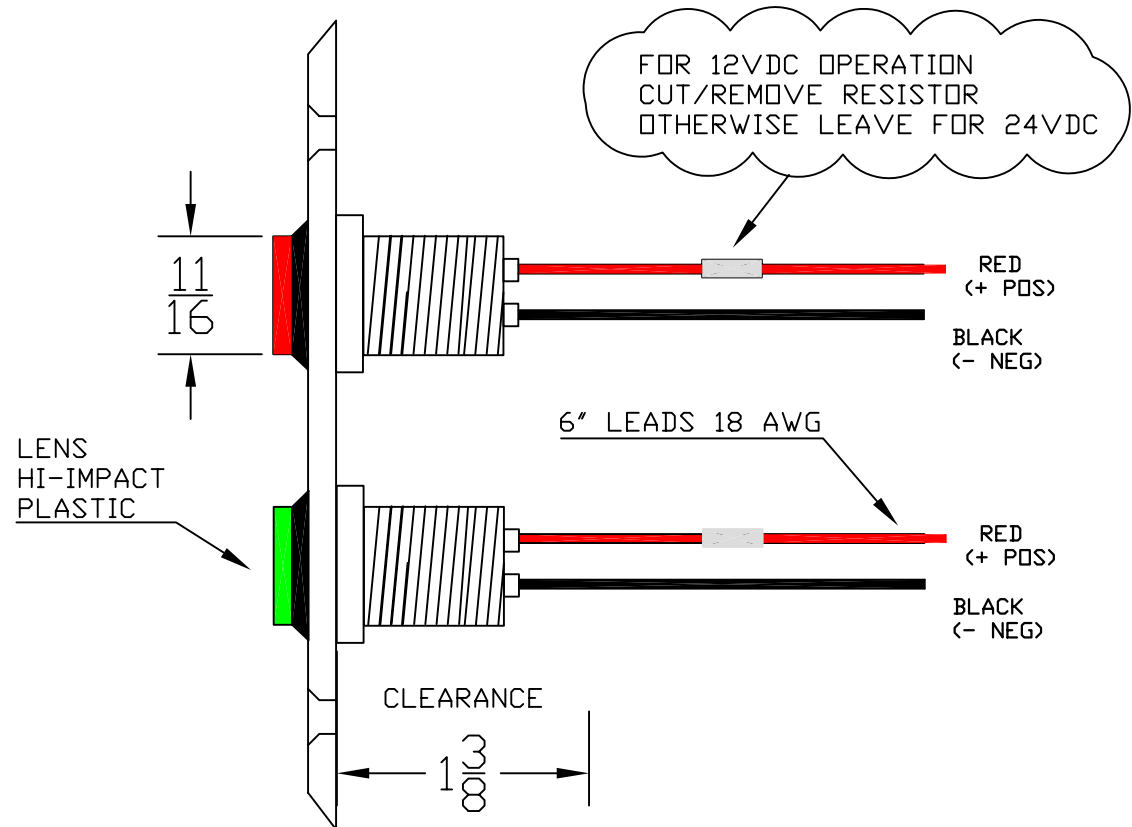
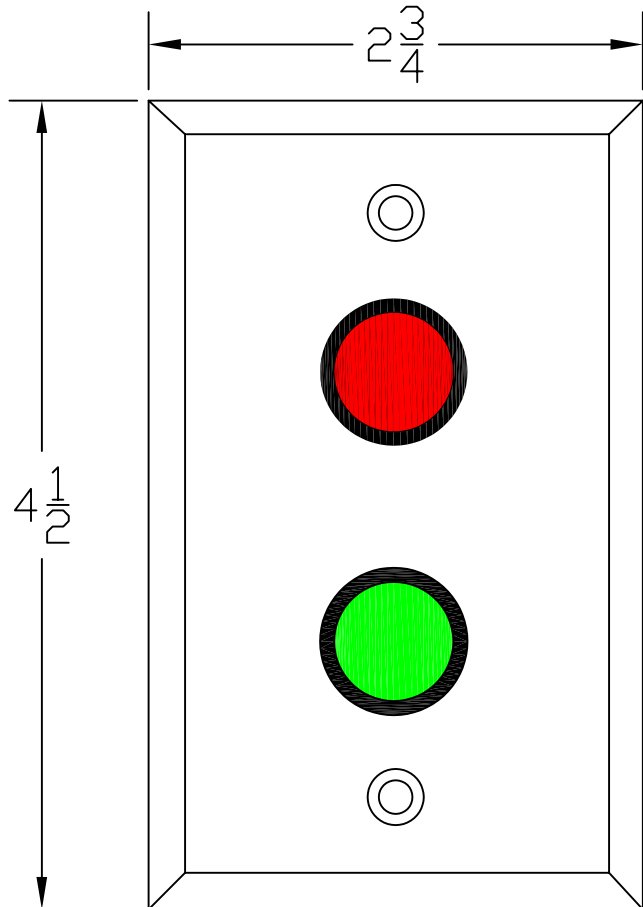

L.E.D. RATING: .04A @ 12-24VDC

 DORTRONICS SYSTEMS, INC.			
		7201XL2-H HI-INTENSITY LED'S	
DATE	2/12/04	FILE	7201XL2-H
DRAWN	JTF	SHEET	1 OF 1 SIZE A

7201xL1R-HXCS

1 GANG STAINLESS STEEL PLATE
HI-INTENSITY LED
SOUNDER

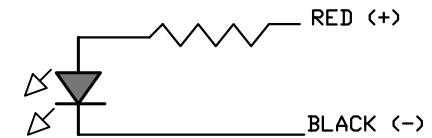
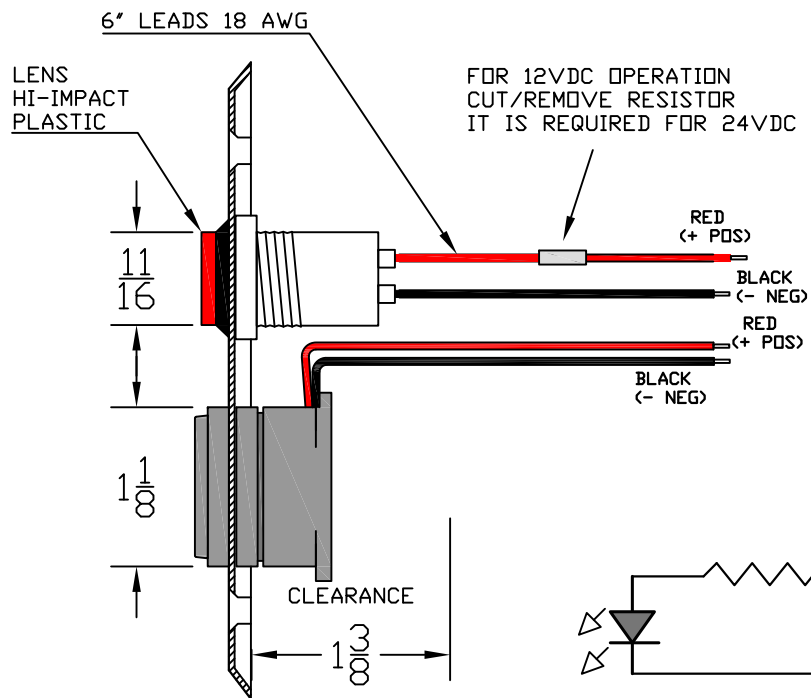
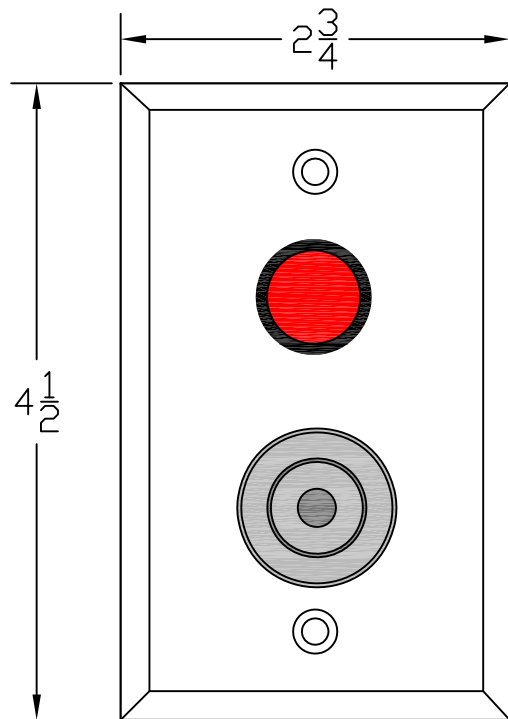

L.E.D. RATING: .04A @ 12-24VDC



DORTRONICS
SYSTEMS, INC.

7201XL1R-HXCS HI-INTENSITY
LED WITH SOUNDER - INSTRUCTIONS

DATE 12/02/09

FILE

DRAWN JFH

SHEET 1 OF 1

SIZE

7201xL1-HWRXCSW

1 GANG STAINLESS STEEL PLATE
 1 HI-INTENSITY WATER PROOF LED
 WITH WATER PROOF PIEZO

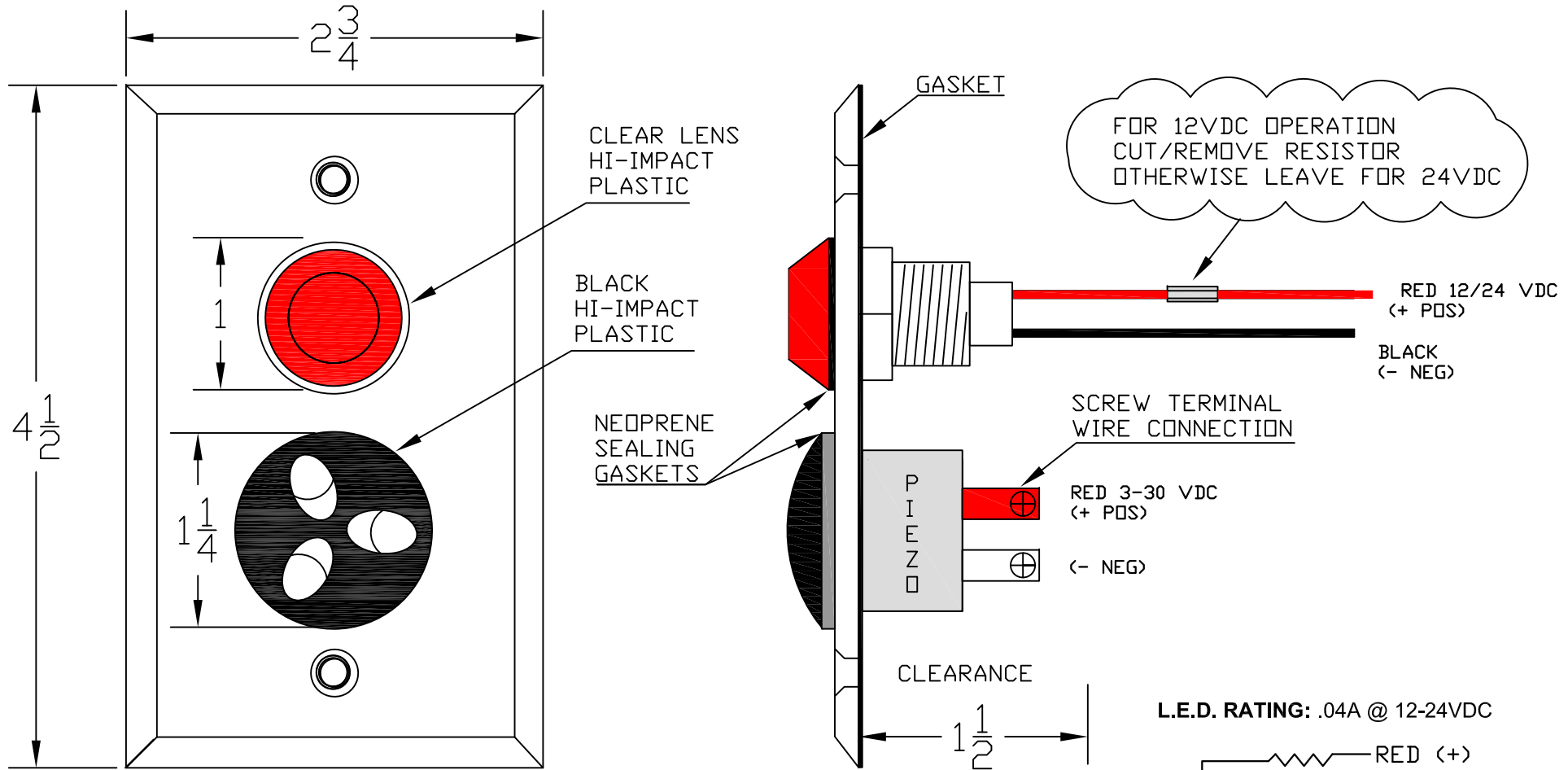

PIEZO RATING:
 5mA @ 5VDC MIN
 80 DB @ 24 IN @ 5VDC MIN

25mA @ 30VDC MAX
 100 DB @ 24 IN @ 30VDC MAX

ASTM B117 Certified (300 hr salt spray)

IP 68 Certified (100 hr water submergence & dust exposure)

L.E.D. RATING: .04A @ 12-24VDC

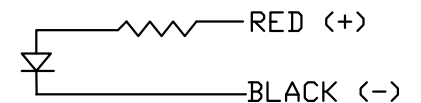

PART NUMBERS:
 7201xL1G-HWRXCS GREEN
 7201xL1R-HWRXCS RED



**DORTRONICS
 SYSTEMS, INC.**

7201XL1-HWRXCSW
 HI-INTENSITY WATER PROOF LED/PIEZO

DATE	10/17/12	FILE	7201XL1-HWRXCSW
DRAWN	JTF	SHEET	1 OF 1 SIZE A

7201xL1-HWR

1 GANG STAINLESS STEEL PLATE
1 HI-INTENSITY WATER PROOF LED

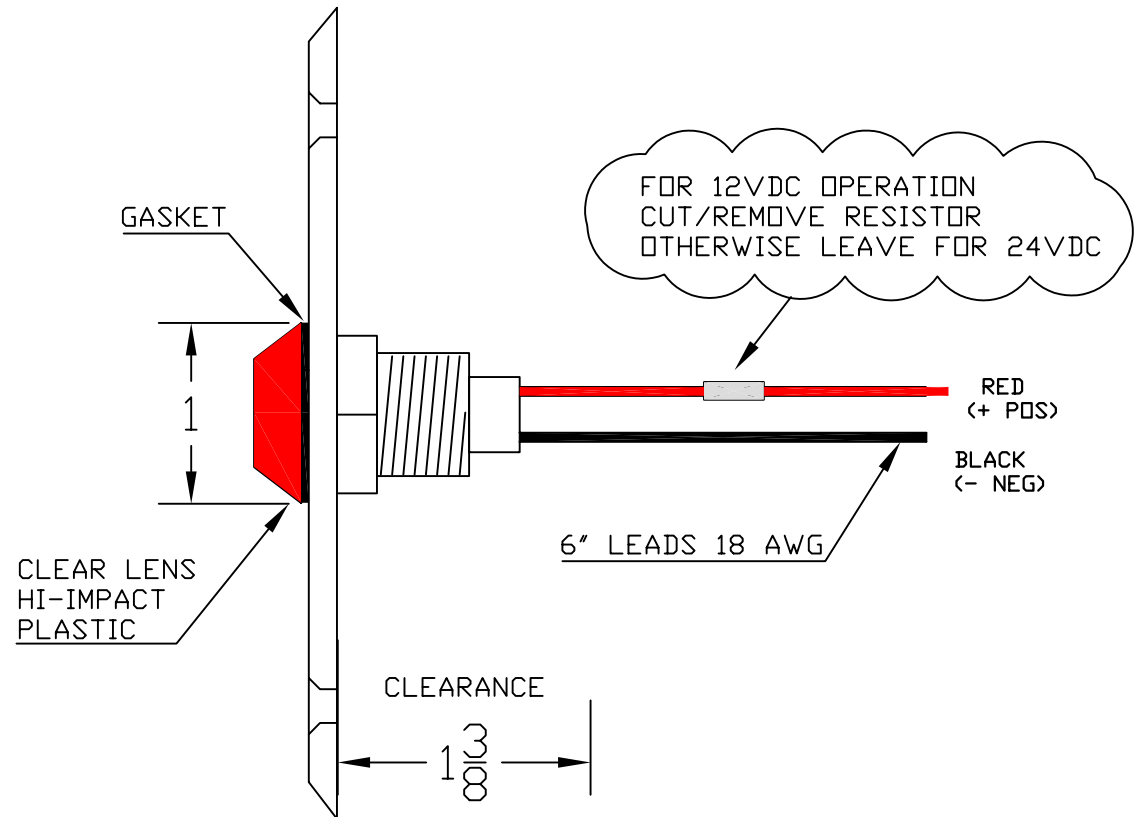
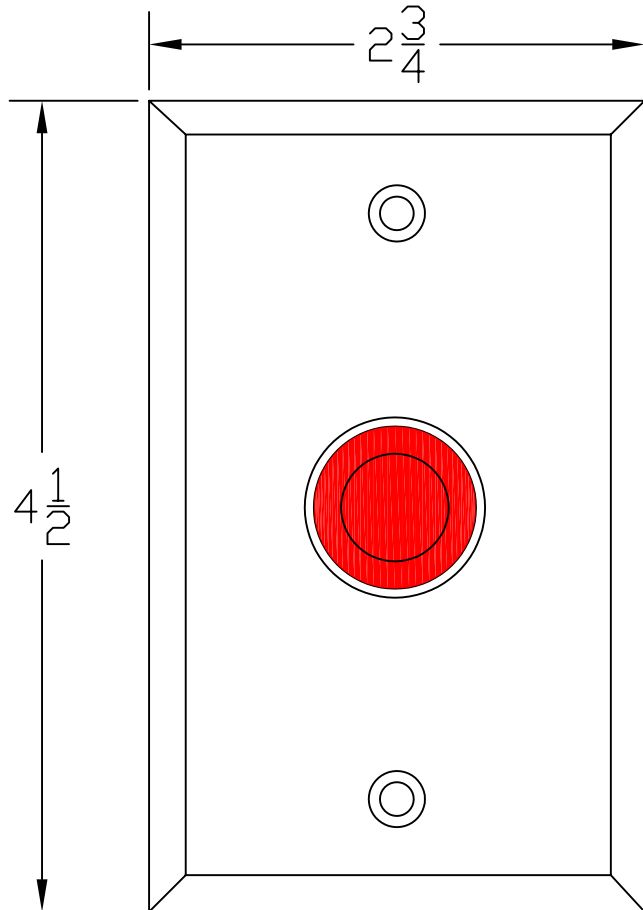

PART NUMBERS:
7201xL1G-HWR GREEN LED
7201xL1R-HWR RED LED

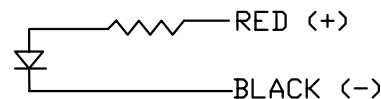

L.E.D. RATING: .04A @ 12-24VDC



**DORTRONICS
SYSTEMS, INC.**

7201XL1-HWR HI-INTENSITY WATER PROOF LED'S			
DATE	2/12/04	FILE	7201XL1-HWR
DRAWN	JTF	SHEET	1 OF 1 SIZE A

7201xL1-H

1 GANG STAINLESS STEEL PLATE
1 HI-INTENSITY LED

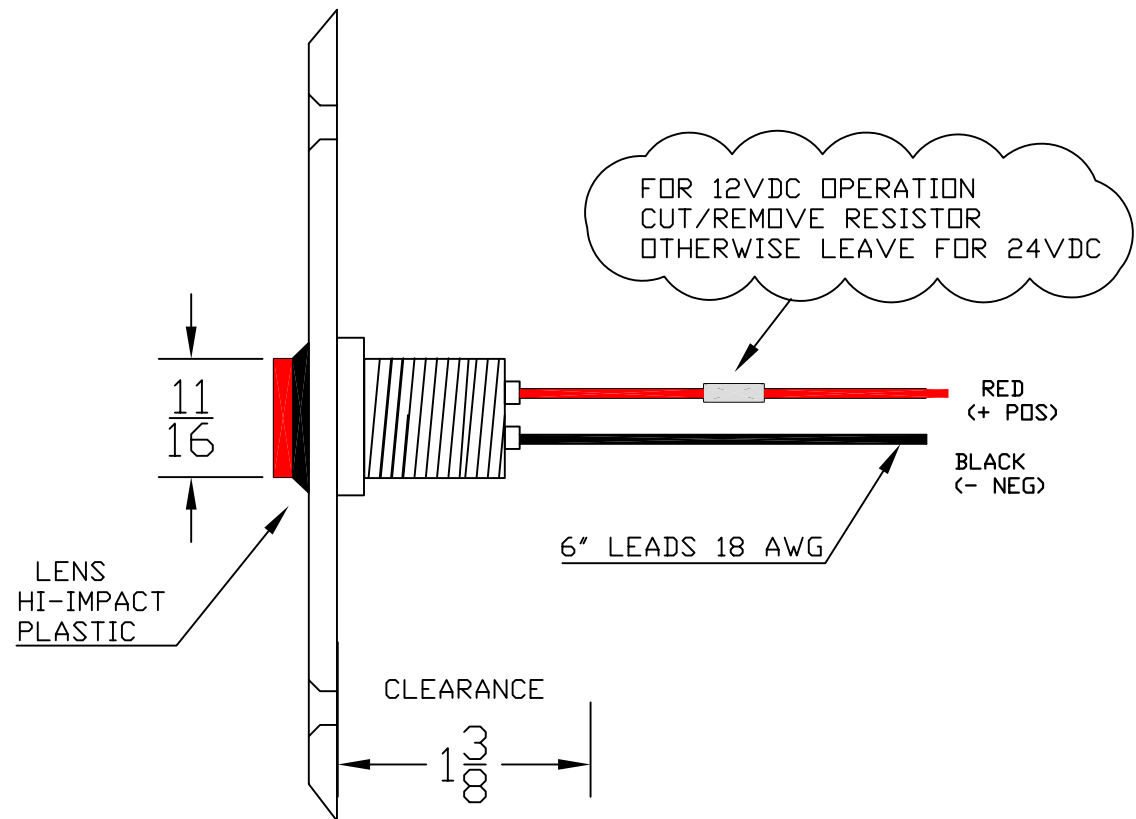
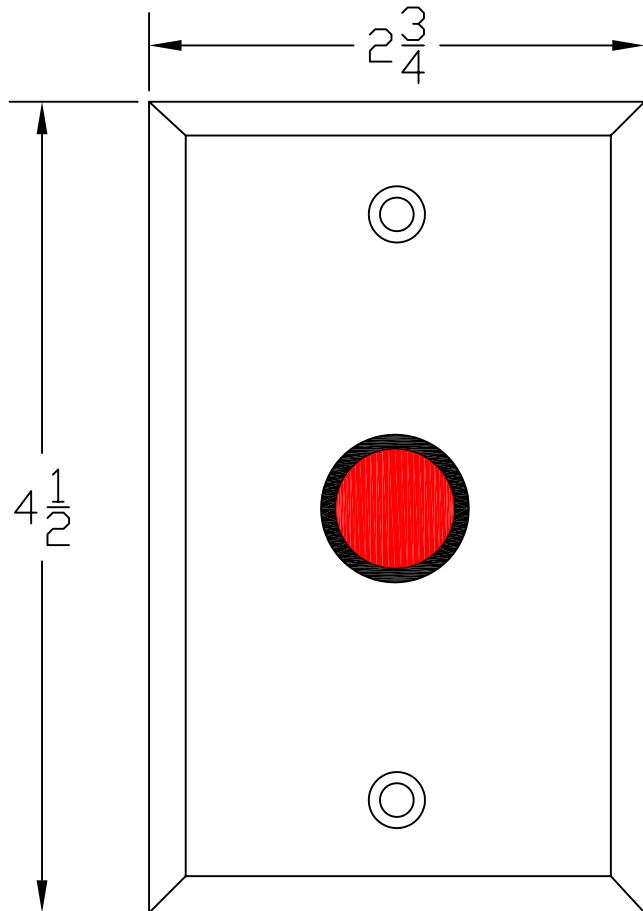

PART NUMBERS:
7201xL1G-H GREEN LED
7201xL1R-H RED LED

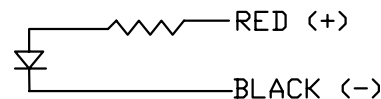

L.E.D. RATING: .04A @ 12-24VDC



**DORTRONICS
SYSTEMS, INC.**

7201XL1-H HI-INTENSITY LED'S			
DATE	2/12/04	FILE	7201XL1-H
DRAWN	JTF	SHEET	1 OF 1 SIZE A

7202xL2-HxCS

2 GANG STAINLESS STEEL PLATE
2 HI-INTENSITY LED'S & PIEZO SOUNDER

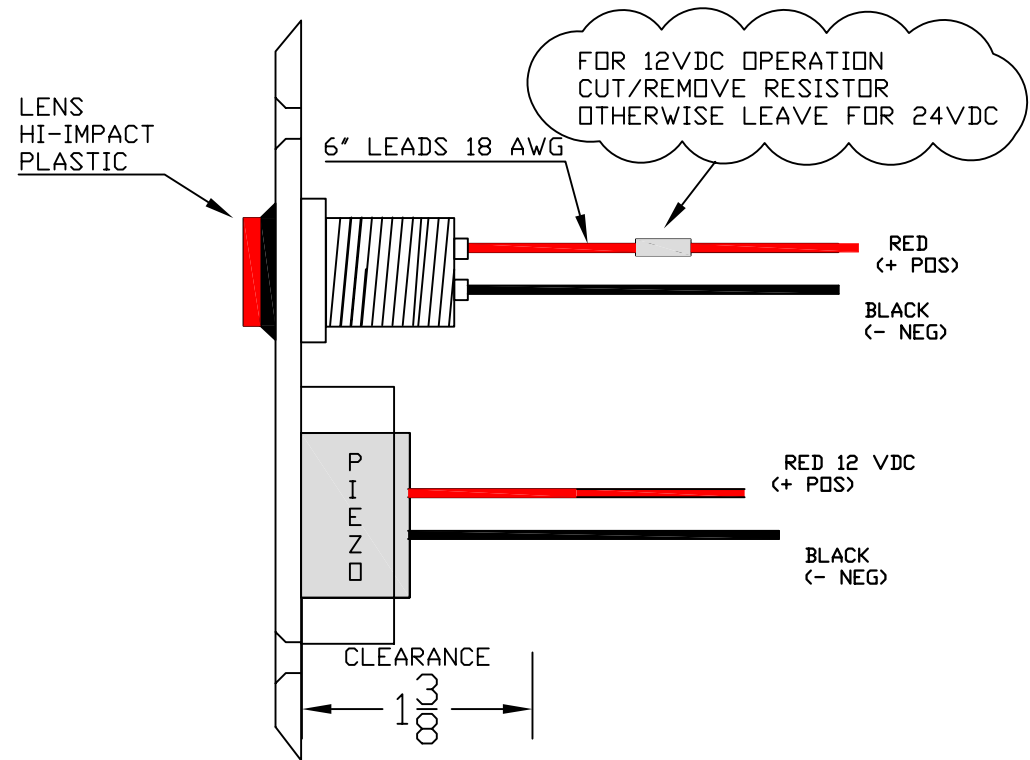
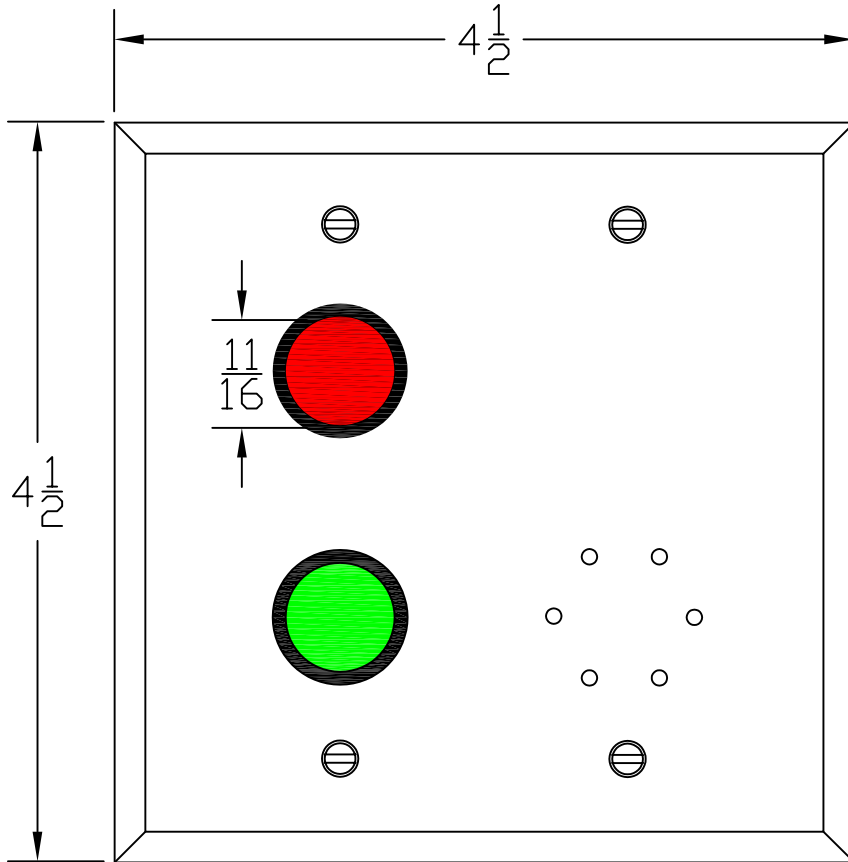

L.E.D. RATING: .04A @ 12-24VDC
PIEZO RATING: 35mA @ 12VDC
95 DBA @ 10 CM (MIN.)

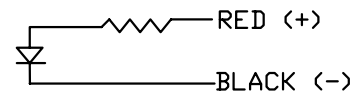

 DORTRONICS SYSTEMS, INC.		7202XL2-HXCS HI-INTENSITY LED'S W/PIEZO	
		DATE 7/7/06	FILE 7202XL2-HXCS
DRAWN JTF	SHEET 1 OF 1	SIZE A	