

# 5286 SERIES INSTRUCTIONS

N5286

W5286

D5286

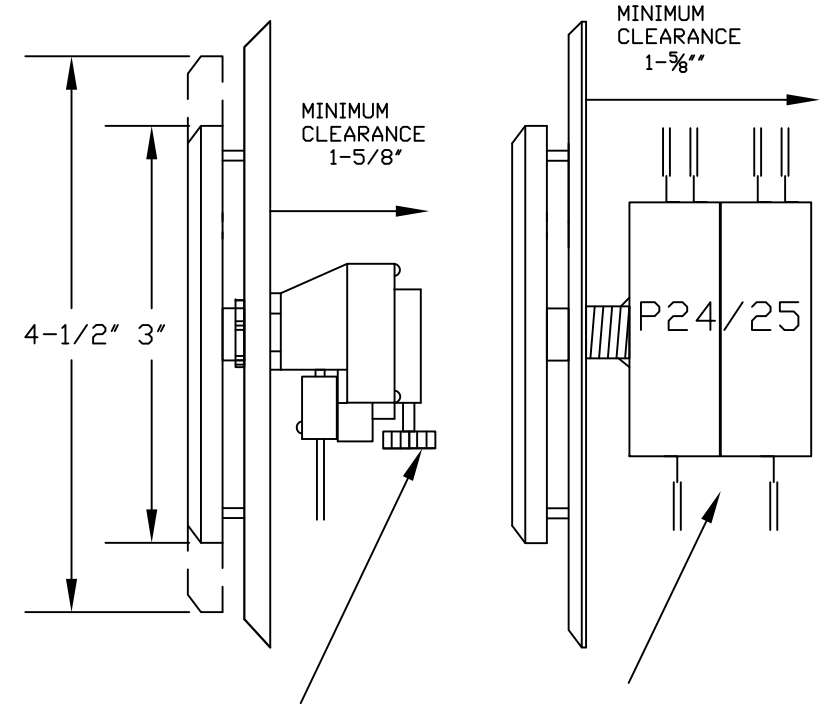
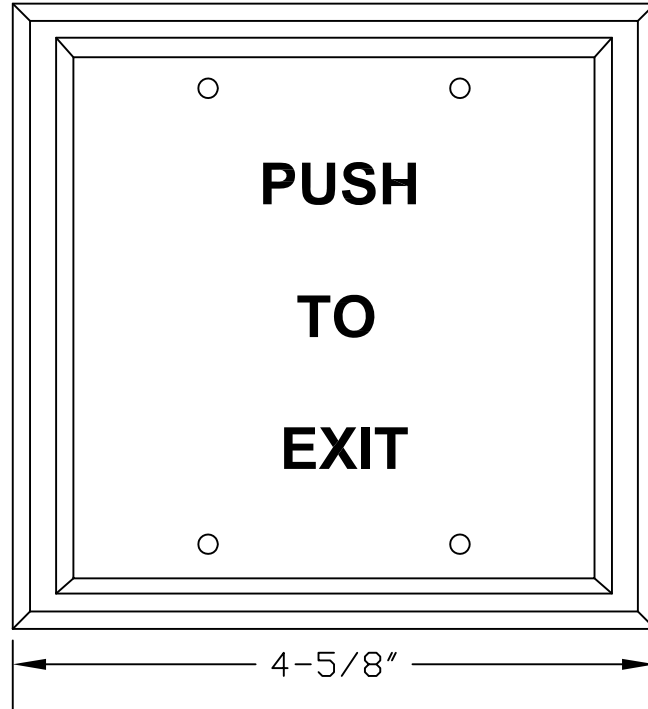
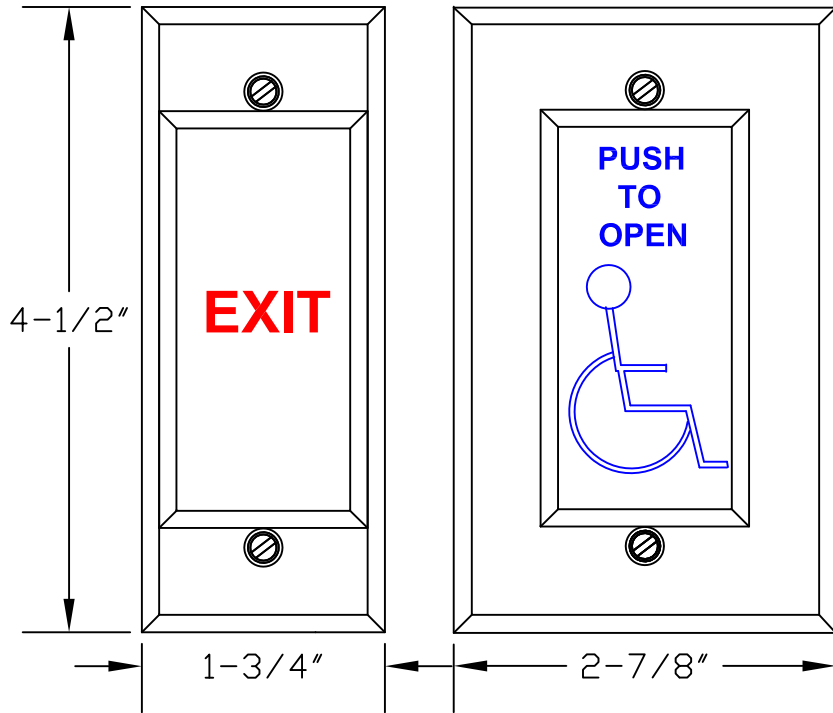

MOUNT WITH 2 SCREWS PROVIDED  
TO 1 GANG UL LISTED/RECOGNIZED  
ELECTRICAL BACK BOX

THE "D" SERIES MOUNTING SCREWS  
ARE CAPTIVATED AND ARE ACCESSED  
WITH THE HEX KEY PROVIDED

PNEUMATIC SWITCH  
ROTATE ADJUSTMENT  
KNOB FROM 2-60  
SECONDS

DPDT SWITCH

OPTIONAL ENGRAVING:

- XE1= PUSH TO EXIT (BLACK TEXT)
- XE1R= PUSH TO EXIT (RED TEXT)
- XE3= EXIT (RED TEXT)
- XE4= DOOR RELEASE (BLACK TEXT)
- XE5= EMERGENCY DOOR RELEASE (RED TEXT)
- XE6= CUSTOM ENGRAVE
- XHCP=HANDICAP
- XHCP2=HANDICAP "PUSH TO OPEN"

PNEUMATIC DELAY  
-P23DA

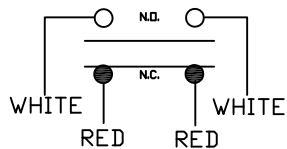

P24 DPDT MAINTAINED SWITCH

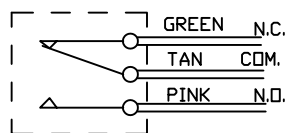
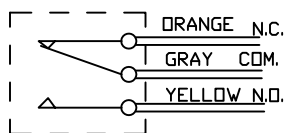

P25 DPDT MOMENTARY SWITCH

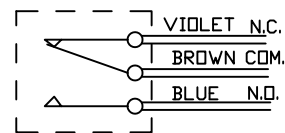
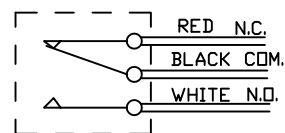

SPECS:  
P24-P25 CONTACT RATING:  
2 AMPS MAX @ 24VDC  
3AMPS @250VAC  
6AMPS @120VAC  
(P23DA ONLY)  
10 AMPS(resistive)@240VAC

PUSH PLATE: 5/16" THICK ALUMINUM  
BACK PLATE: 1/8" THICK ALUMINUM

PART#52860  
REV#001C  
9/8/10

5286 SERIES  
PUSH PAD SWITCH ASSEMBLY



**DORTRONICS**  
SYSTEMS, INC.  
SAG HARBOR, NY  
800-906-0137



## 4505 ADJUSTABLE TIMER INSTRUCTIONS

The 4505 processor controlled timer module may be used as a highly accurate 30 second fixed timer or by removing a jumper, may be adjusted to provide endlessly variable time settings from 1 to 60 seconds. It features separate trigger inputs for either normally open or normally closed contacts.

Bi-color LEDs may be wired directly to a powered connector for remote indication of timer status.

Delay on power-up is selectable by jumper. With the switch bracket option, the timer mates with the Dortronics 5286 switch series and is designed to fit into a standard single gang electrical box.

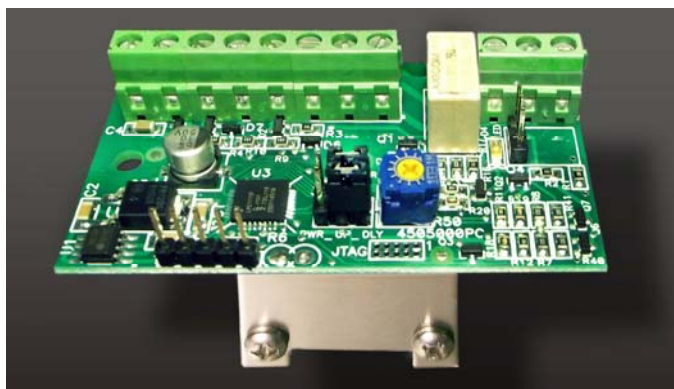
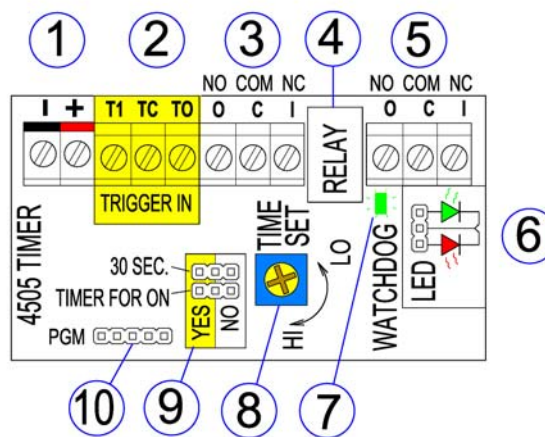

FIG. 1 LOCK AND RECEIVER PLATE



- |   |               |   |              |    |              |
|---|---------------|---|--------------|----|--------------|
| 1 | Power Input   | 5 | Output 2     | 9  | Jumper Array |
| 2 | Trigger Input | 6 | LED Header   | 10 | PGM Port     |
| 3 | Output 1      | 7 | Watchdog LED |    |              |
| 4 | DPDT Relay    | 8 | Time Adjust  |    |              |

### POWER INPUT (1)

The 4505 requires 12 – 24 VDC. The 4505 can be configured to trigger on power up. See Jumper Array (9) below. This feature is often used to add a timed unlock period to an existing lock when only power connections are available at the door.

### TRIGGER INPUT (2)

The timer trigger can be either a normally closed or a normally open contact. An input is provided for both. To use a normally open contact, the normally closed trigger should be tied to common. Do not apply voltage to the trigger inputs, Use dry contacts only.

The relay de-energizes when a trigger is detected. The timing sequence begins when the trigger is removed.

The 4505 is designed for Fail Safe operation. **The relay is not energized when the timer is running.** Fail secure operation is available as an option.

### OUTPUT ONE (3)

There are two sets of DPDT relay contact sets available as timer outputs. Output One with a common, a normally closed and a normally open contact using standard terminal strip for connection is also available with a 3 pin header as an option.

### DPDT OUTPUT RELAY (4)

The output relay contacts are rated for 2 Amps at 30 VDC.

### OUTPUT TWO (5)

The second set of relay contacts (common normally closed and normally open) is available as a standard three-position terminal strip.

### LED OUTPUT (6)

A powered output is available for direct connection to a bi-color LED (or a pair of discrete LEDs). The output changes state when the relay is energized. Most users connect a bi-color LED to the header such that RED is illuminated when the relay is not energized and GREEN is energized when the relay is energized. Since the center pin is common, to reverse the color order, merely rotate the orientation of the plug.

### WATCHDOG LED (7)

The 4505 timer is controlled by a microprocessor. A watchdog circuit monitors the operation of the microprocessor and blinks at a steady rate (about 3 times per second) when the processor is operating correctly. This provides a continual visual indication that the system is operational.

If the Watchdog Circuit stops blinking at a constant rate, contact Dortronics Technical Help.

Always use transient voltage protection on the outputs when connecting an inductive load. Kickback (back EMF) from a coil can destroy relay contacts and may damage the electronics. Transient Voltage Suppression (TVS) diodes are available from Dortronics for \$1.00 ea. Part # 1200036. Connection of an inductive load without protection will void the warrantee.

### TIME DELAY ADJUST (8)

The 4505 timer delay period can be adjusted from 1 to 60 seconds by means of a rotary control. Use a small screw driver to increase the delay time by turning the control clockwise or decrease the delay time by rotating the control counter-clockwise. Longer time delays may be custom programmed at the factory for a small additional cost.

JUMPERS FOR: 30 SECOND FIXED DELAY AND DELAY ON POWER-UP (9)

The 4505 timer delay period can be accurately set at thirty seconds by moving the top fixed delay jumper to the left two pins. See the diagram above. The 30 second delay has the accuracy of a computer and is not affected by barometric pressure or changes in the ambient temperature.

For the timer to trigger on power up, move the lower jumper to the left two pins. This is a useful function for retrofitting a timed relock delay to existing door locks wired for power only with no control wiring available. When the power circuit is briefly interrupted (usually by a momentary pushbutton in series with the lock) the system goes immediately into the timer function as soon as the power is restored. This converts an existing momentary release switch into either a fixed 30 second door release or an adjustable release (from 1 to 60 seconds).

PROGRAMMING PORT (10)

The 4505 can be customized at the factory for non-standard applications. The time delay range can be easily increased by seconds, minutes or even hours for a small additional programming charge. Other custom features will be quoted on the basis of customer specifications.

SPECIFICATIONS:

POWER INPUT:	12 – 24 VDC
TIMER RANGE:	1 – 60 SECONDS
FIXED TIME:	30 SEC
RELAY CONTACT RATING:	2 Amp @ 30 VDC Max.
SIZE:	2 3/4" X 1 1/2" – Requires 3/4" height clearance for connections
TRIGGER:	Normally Open and Normally Closed Trigger Inputs
OPERATION:	Output Relay is <b>NOT</b> energized during Timer Function
TRIGGER HOLD OVER:	Relay is energized on trigger, timer countdown begins at trigger release

TIMER SOLUTIONS:

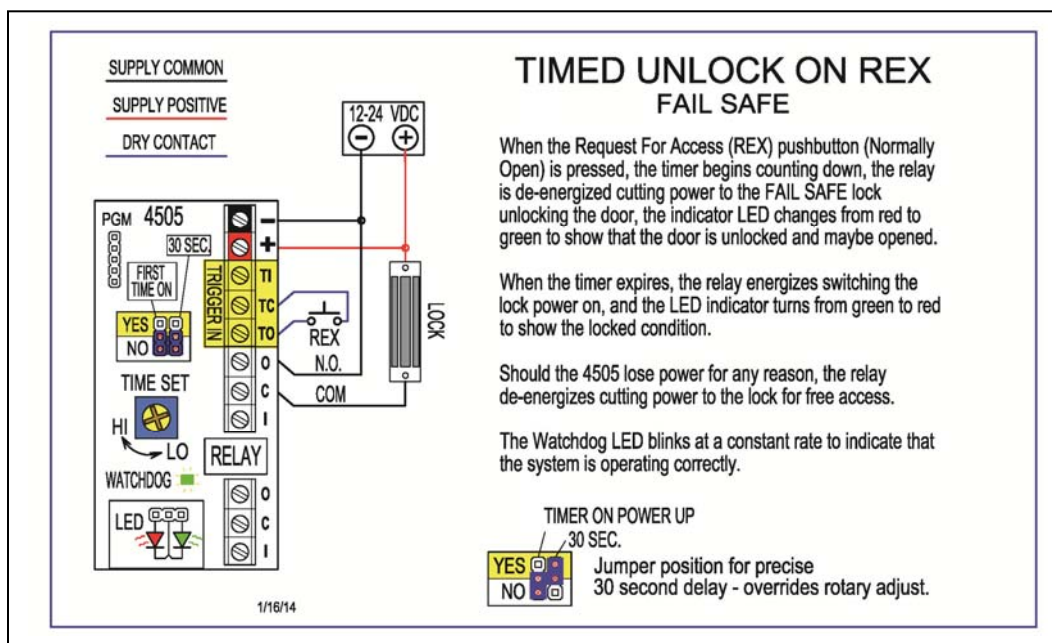

### SWITCH POWER TO TRIGGER RETRO FIT EXISTING LOCK

SUPPLY COMMON  
SUPPLY POSITIVE  
DRY CONTACT

1/16/14

To add a time delay for installations with an existing lock and a pushbutton used to cut power to the lock for access, where it is not practical to pull additional wiring, the timer may be connected in line with the existing lock power circuit.

Move the jumper to the position for time delay on power up (see illustration below) and adjust the delay control for the unlock time desired.

When the pushbutton is pressed cutting power to the lock and the timer, the door is unlocked. When the pushbutton is released and power is restored, the timer begins counting down and the door remains unlocked until the time delay expires.

The Watchdog LED blinks steadily to indicate correct operation.

TIMER ON POWER UP  
30 SEC.

**YES** Jumper position for precise  
**NO** 30 second delay - overrides rotary adjust.

### DOOR PROPPED OPEN ALARM WITH MANUAL RESET

POWER SUPPLY COMMON  
POWER SUPPLY POSITIVE  
DRY CONTACT ONLY

Mar 24 2015

The system remains triggered in normal mode by the closed contacts of the door position switch. The door is closed. The sounder is silent. The LED indicator is green to show that the system is in normal mode. (Upon initial power up a Reset must first be initiated for normal operation)

When the door opens, the trigger is removed and the timer begins to count down. If the door is closed prior to the expiration of the timer, the system remains in normal mode.

If the door is still open when the timer expires, the system goes into alarm mode: the horn sounds; the indicator LED changes to red to show the alarm condition; and the relay de-energizes, interrupting the trigger circuit.

Closed contacts at the Reset Switch (usually a keyed switch) are required re-trigger the system, turn off the alarm and restore normal mode.

The Watchdog LED blinks at a constant rate to indicate that the system is operating correctly.

### DOOR ALARM ON OPEN RESET ON CLOSE

SUPPLY COMMON  
SUPPLY POSITIVE  
DRY CONTACT

1/16/14

When the door opens, the Door Position Switch contacts open triggering the timer. The alarm sounds immediately. The status LED changes from green to red and the relay de-energizes causing the horn connected to the Normally Closed relay contacts to sound.

When the door closes, the trigger is removed. When the timer runs out the system returns to normal mode: the relay is de-energized, the status LED is green and the horn is silent.

Note: reverse the LED connector to change the color in Normal Mode

The Watchdog LED blinks at a constant rate to indicate that the system is operating correctly.

**REMEMBER: when not triggered, the output relay is energized.**



### **Product Warranties:**

4500 Series Timers have a One Year Warranty against defects in material and workmanship. Defective units will be replaced or repaired based upon incoming evaluation and inspection.

All other Dortronics components of the Electric Locking System shall be similarly warranted for a period of one year. Expressed warranties are conditionally based on the requirement that the items covered within the guarantee are used and maintained in accordance with the manufacturer's recommendations.

A Return Authorization Number must be obtained and accompany all returns within 14 days of issue. Unused items returned for credit must be complete and packed in original unit box and are subject to a 15% restocking fee. Any shipping or order discrepancies must be reported within 5 days of receipt.

### **Contact (Sales):**

**Mike Palermo** – Sales/Customer Service

**Stuart Arthur** – Sales/Applications Specialist

**Bryan Sanderford** - National Sales Manager]

### **Contact (Technical):**

**Joe Hanna** – Engineer/Applications Specialist

### **Contact (Credit):**

**Teri Harboy** – Accounting; New Customer Accounts

Dortronics Systems Inc. 800-906-0137 Fax 631-725-8148 [www.dortronics.com](http://www.dortronics.com)